

HEADLIGHT CATALOG

AUTOMOTIVE • POWERSPORT • TRANSPORT • INDUSTRIAL

J.W. SPEAKER 
Engineered. Lighting. Solutions.

J.W. SPEAKER BRINGS SCIENCE & DESIGN TOGETHER.

We view vehicle lighting from the perspective that matters most — Yours. Our engineers advance the science of light further each day to improve your safety. Our designers make vehicles look more beautiful from every point of view. You only get this unique mix of **science & design** from authentic J.W. Speaker products.

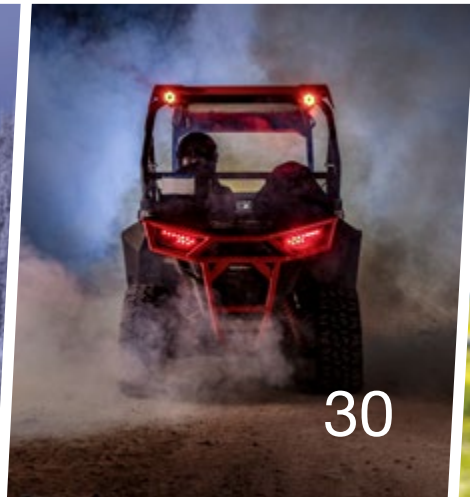

AUTOMOTIVE



POWERSPORT



TRANSPORT



INDUSTRIAL

TABLE OF CONTENTS

Company Overview	4-5
Regulations & Key Terms	6
Lumens & Beam Patterns	7
Color Temperature & IP Ratings	8
Icon Guide	9
Automotive	10-25
Powersport	26-53
Transport	54-87
Industrial	88-103
OEM	104
Aftermarket	105

DRIVEN. TO SEE MORE.



We recognize that in order to be the best, we must remain focused on developing innovative and high-quality LED vehicle lighting solutions that are second to none. We understand the need to constantly explore new and emerging LED technologies with the goal of providing better performance for our OEM and aftermarket customers.

A LEGACY OF INNOVATION

OEM ORIGINS AND AFTERMARKET ADVANCEMENT

A lot has changed since J.W. Speaker became the leader in LED lighting technology. Vehicles are sleeker. Lights are brighter. And the world seems both larger — yet smaller — than ever before.

But some things remain the same. J.W. Speaker continues its commitment to innovative LED lighting systems. Established in scientific principles and revolutionary design — we're continuously striving for the next great discovery. We're still excited with every new product launch. We're still compelled to impress every customer. And we're still driven to see more.

We understand what's most important; J.W. Speaker engineers and designers transform the science of light into tangible real-world LED solutions to enhance every driving experience and keep you safer on the road. Because we manage everything — from conception to production — we can meet your exacting demands for performance, as well as our own for perfection.

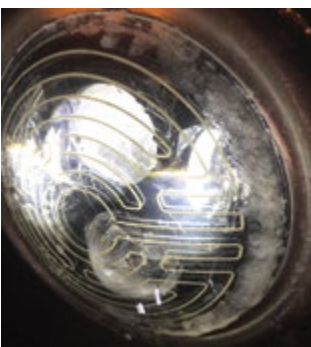

- 1935 John W. Speaker founded the J.W. Speaker Corporation
- 1942 Designed and patented the iconic P-38 GI can openers
- 1951 Tools their first vehicle lighting products
- 1964 Introduces all-plastic clearance & marker lights with snap-fit lenses
- 1971 First company to use chrome-plated ABS for snowmobile headlight bezel
- 1982 First production of custom-designed lightbar for Ariens
- 2002 First LED headlight prototype developed
- 2011 Patent granted for first digital LED swiveling headlight
- 2012 Entered aftermarket with the first of its kind 7" round LED headlight for Jeeps
- 2015 Launched the world's first Adaptive® Headlight Series
- 2017 Launched SmartHeat® technology
- 2019 Released EVO J3™ headlight and Trail 6™ off-road light
- 2020 Released 9600 Peterbilt POD LED headlight
- 2022 Released Mosaic Modular Lighting System and the Model 93 5-in-1 90mm headlights

SURPASSING STANDARDS WORLDWIDE.

J.W. Speaker is committed to making the best products to be used legally on-road around the world. To do that, we design lights that meet and exceed the requirements for a variety of regulations:



The Federal Motor Vehicle Safety Standard regulates all automotive lighting, signaling, and reflective devices in the U.S.A. and is enforced by the Department of Transportation (**DOT**)



Many countries recognize the United Nations Economic Commission for Europe (**ECE**) Transport Division's regulations and mirror the ECE regulations in their own national requirements



SAE International develops standards for the engineering of powered vehicles mainly in the U.S.A. and Canada, including cars, trucks, boats, aircraft, and more



Transport Canada is responsible for developing regulations, policies, and services relating to transportation in Canada



The Australian Design Rules (**ADR**) are national standards for vehicle safety, anti-theft, and emissions

KEY TERMS

Daytime Running Light (DRL): Headlights that include DRL in their design will automatically switch on the daytime running light when the vehicle is moving forward, emitting a white light to increase the visibility of the vehicle during daylight conditions.

Front Position (FP): This part of a headlight provides added visibility of your vehicle to other drivers, particularly helpful for nighttime visibility while parked.

Left Hand Traffic (LHT): referring to which side of the road a driver uses. For instance, a driver in the UK is Left Hand Traffic and would use two LHT lights.

Right Hand Traffic (RHT): referring to which side of the road a driver uses. For instance, a driver in Canada is Right Hand Traffic would use two RHT lights.



RAW LUMENS:

A measure of the **theoretical** output of a light

Calculated by multiplying the manufacturer's lumen rating for the LED by the number of LEDs in the finished light

Does not represent the actual light output as it doesn't account for thermal, assembly and optical losses that impact all lights

Example Calculation:

LED is rated at 100 Lumens
8 LEDs in the finished light
100 x 8 = 800 Raw Lumens

EFFECTIVE LUMENS:

A measure of the **actual** output of a light

Measured using a photometric testing device for an exact measurement of a finished light for an accurate value of light output

Represents the actual light output of the finished light after thermal, assembly and optical losses

Example Measurement:

Raw Lumens = 800
Losses = ~40% of Raw Lumens (800 x .4 = 320)
800 - 320 = 480 Effective Lumens

J.W. Speaker uses photometric testing devices and optical engineers to measure the Effective Lumens of our products to give you accurate light output values.

BEAM PATTERNS

Each light pattern is designed and tested by optical engineers to give you the best possible beam pattern to drive behind.

Our engineers design each product to project light in the areas you need it **and** comply with the legal requirements for on-road use in the countries the product is intended to be used in.

Below are examples of the common beam patterns.

Low Beam RHT (.75m high at 0')

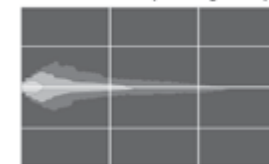

Illuminates across the road and ahead of the vehicle, with a cutoff to prevent glare for oncoming traffic

High Beam (.75m high at 0')

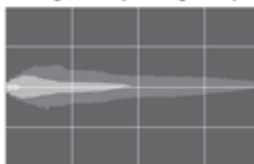

Bright light for distance illumination above and below the horizon, when not following or passing vehicles

Fog Beam (.5m high at 0')



Short and wide pattern to illuminate area just above the ground & in front of the vehicle

PARTS OF A LIGHT DIAGRAM

Lux Key¹: Intensity of the light measured

Title²: The type of beam pattern, and the height and angle of the light when it was measured

Light Pattern³: A "bird's eye view" showing the shape, intensity, and distance

Distance Markers⁴: Reference in meters (m) for the size and distance of the light pattern

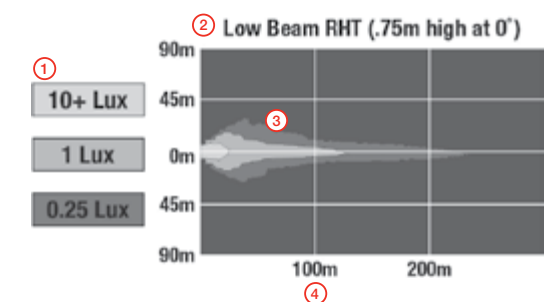

Measured in degrees Kelvin, color temperature describes how cool or warm the light emitted by a source is. Any object will emit light if it is heated to a high enough temperature. The color of the light will change in a predictable way as the temperature increases, shown on the Kelvin Scale.

Warm: 0 to 3,000K

Used in living spaces or retail stores
Similar to the rising and setting sun
Can fatigue eyes and make people feel tired

Neutral White: 3,500 to 4,900K

Used in bathrooms, offices, classrooms & malls
Clean and neutral lighting that is inviting
Promotes efficiency and similar to daylight

Cool: 5,000-7,000K

Used in hospitals, manufacturing, & construction areas
Promotes alertness and attention to detail
Mimics daylight and makes people feel more awake

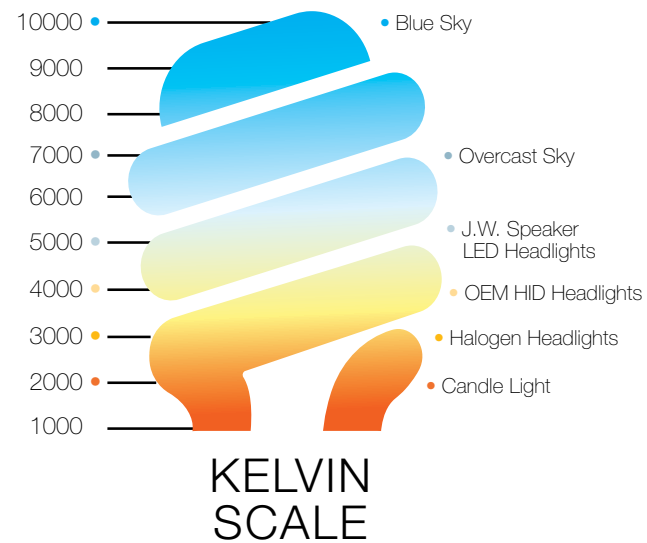

Color temperature does not measure or indicate the physical heat coming from a light source.

J.W. Speaker uses LEDs and designs lights with a color temperature of 5,000K to give drivers crisp, white light for the best visibility, and to promote alertness and safety.

IP RATINGS

The Ingress Protection (IP) Code outlines a system of classification for the protection of electrical enclosures against the intrusion of foreign bodies like tools, fingers, dust, and moisture. The system of classification was specified by the International Electrotechnical Commission and is officially designated as IEC 60529.

FIRST # - DEGREE OF INGRESS PROTECTION

The degree of protection against contact with moving parts and the degree that the equipment is protected against solid foreign bodies intruding into an enclosure.

IP #	DESCRIPTION
0	No protection provided.
1	Protection against entry of objects larger than 50 square mm.
2	Protection against entry of objects larger than 12 square mm.
3	Protection against entry of objects larger than 2.5 square mm.
4	Protection against entry of objects larger than 1.0 square mm.
5	Protection against entry of dust in sufficient quantity to prevent satisfactory operation.
6	Complete protection against entry dust.

SECOND # - DEGREE OF MOISTURE PROTECTION

The degree of protection for the equipment inside the enclosure against the harmful entry of various forms of moisture (e.g. dripping, spraying, submersion, etc.)

IP #	DESCRIPTION
0	No protection provided.
1	Protection against drops of water falling vertically.
2	Protection against drops of water falling vertically when the light assembly is tilted up to 15 degrees from its normal position.
3	Protection from entry of water spray from angle of up to 60 degrees from vertical.
4	Protection from entry of water splashes or spray from any direction.
5	Protection from a low pressure jet of water in any direction.
6	Protection against heavy seas or a strong jet of water in any direction.
7	Protection against immersion up to 1 meter.
8	Protection against submersion over 1 meter.
9K	Protection against high pressure cleaning

AUTOMOTIVE = ■

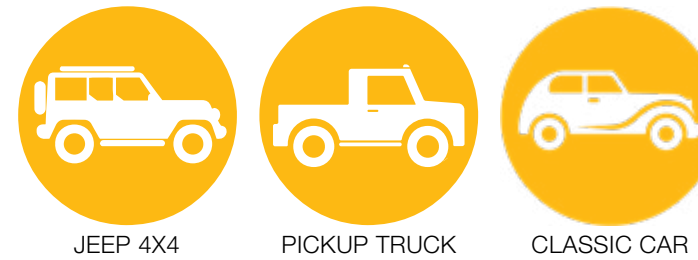

POWERSPORTS = ■

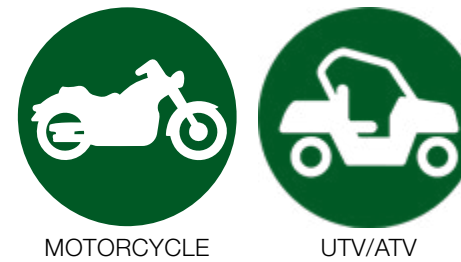

TRANSPORT = ■

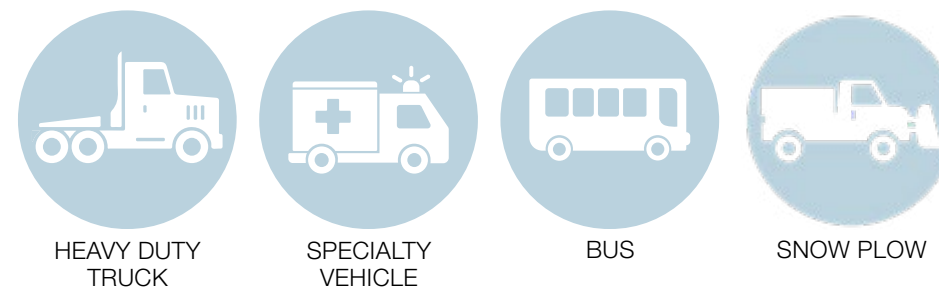

INDUSTRIAL = ■





AUTOMOTIVE

Products featured: Model 8700 Evo 2 Classic, Model Evo J3™, and 8700 Evo J2

EVO J3™

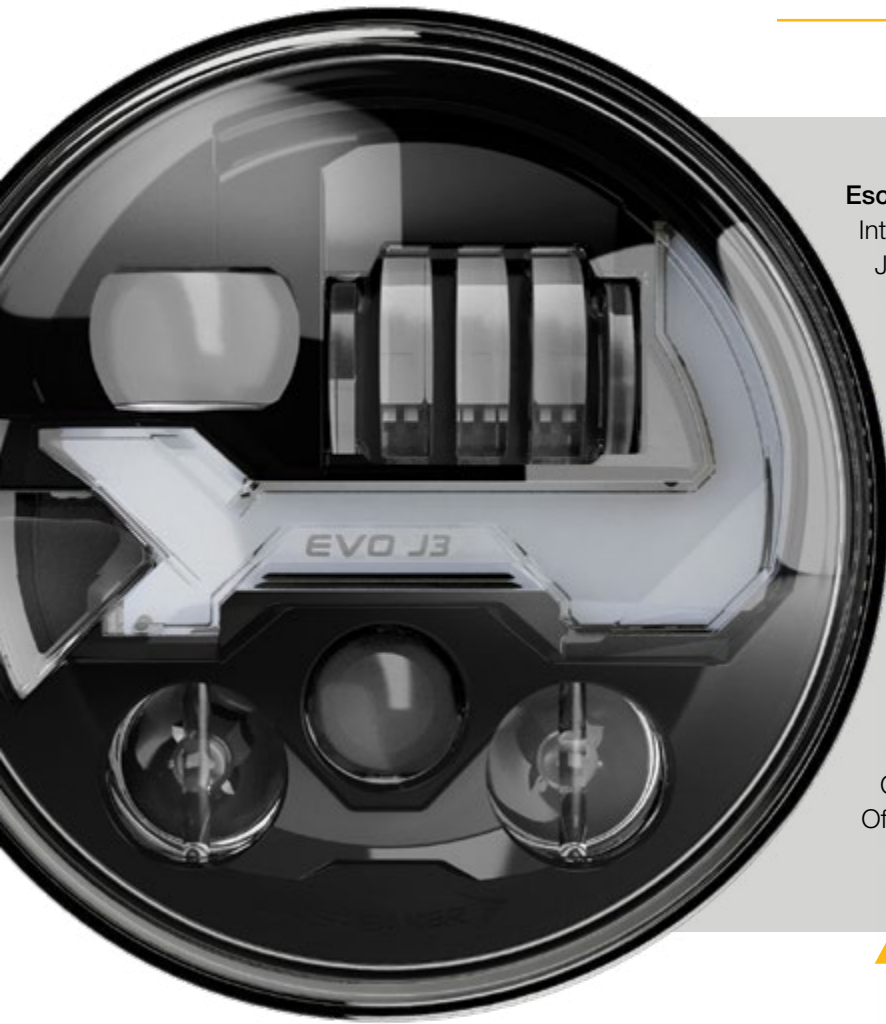

Escape the standard.

Introducing the latest technology in lighting for Jeep® Wranglers. The EVO J3 is the first street-legal, plug & play Jeep headlight with a built-in turn signal. Powerful LEDs and carefully engineered light patterns give you the best performance and design available whether on the road or exploring off-road.

Light your adventure all year round.

The heated version of the EVO J3 features SmartHeat® technology to de-ice lenses for the best safety and visibility.

Customization & control at your fingertips.

Unlock more control and features in the EVO J3 using the new J-Link™ mobile app. Customize your startup sequence, access the Off-Road Mode and lead the trail with Guide Mode.



EVO J3

PRODUCT SPECIFICATIONS

Raw Lumen Output:

3,600 (High Beam); 3,020 (Low Beam)

Effective Lumen Output:

1,320 (High Beam); 1,201 (Low Beam)

Candela Output:

68,800 (High Beam); 24,800 (Low Beam)

Connector/Wiring:

H13 Delphi 15326813

Operating Voltage:

9-16V DC

Current Draw:

Low Beam: 2.33A @ 12V DC

High Beam: 3.25A @ 12V DC

Front Turn: 3.00A @ 12V DC

DRL: 3.00A @ 12V DC

Front Position: 0.45A @ 12V DC

Retrofit Information:

Jeep JK 2010-2018

Standards & Application:



TURN SIGNAL



OFF ROAD MODE



DRL



LOW BEAM & TURN SIGNAL



LOW BEAM



HIGH BEAM

UNLOCK FEATURES WITH
J-LINK™

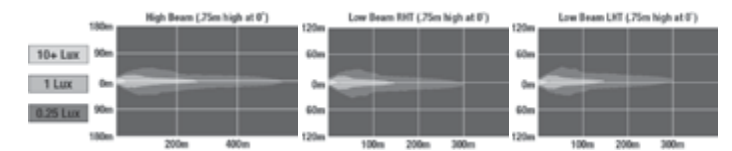
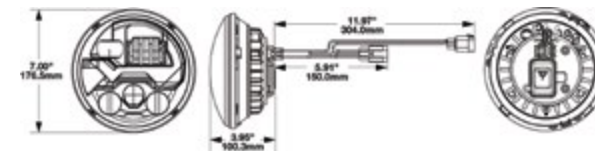

HEATED SINGLE HEADLIGHTS

PART #	BEZEL	DESCRIPTION
0556461	Graphite	12V DOT Heated High & Low Beam w/ Turn - RH
0556471	Graphite	12V DOT Heated High & Low Beam w/ Turn - LH
0557271	Black	12V DOT Heated High & Low Beam w/ Turn - RH
0557281	Black	12V DOT Heated High & Low Beam w/ Turn - LH
0558221	Black	12V DOT Heated High & Low Beam w/ Turn - RH (Canada)
0558231	Black	12V DOT Heated High & Low Beam w/ Turn - LH (Canada)

HEATED KIT OF 2 HEADLIGHTS

PART #	BEZEL	DESCRIPTION
0555613	Graphite	12V DOT Heated High & Low Beam w/ Turn - Kit of 2
0557213	Black	12V DOT Heated High & Low Beam w/ Turn - Kit of 2
0558153	Black	12V DOT Heated High & Low Beam w/ Turn - Kit of 2 (Canada)

NON-HEATED SINGLE HEADLIGHTS

PART #	BEZEL	DESCRIPTION
0556441	Graphite	12V DOT High & Low Beam w/ Turn - RH
0556451	Graphite	12V DOT High & Low Beam w/ Turn - LH
0557251	Black	12V DOT High & Low Beam w/ Turn - RH
0557261	Black	12V DOT High & Low Beam w/ Turn - LH
0558181	Black	12V DOT High & Low Beam w/ Turn - RH (Canada)
0558191	Black	12V DOT High & Low Beam w/ Turn - LH (Canada)

NON-HEATED KIT OF 2 HEADLIGHTS

PART #	BEZEL	DESCRIPTION
0555593	Graphite	12V DOT High & Low Beam w/ Turn - Kit of 2
0557193	Black	12V DOT High & Low Beam w/ Turn - Kit of 2
0558143	Black	12V DOT High & Low Beam w/ Turn - Kit of 2 (Canada)

▲ WARNING: Cancer and Reproductive Harm - www.P65Warnings.ca.gov
▲ AVERTISSEMENT: Cancer et effet nocif sur la reproduction - www.P65Warnings.ca.gov



TRAIL 6 SPORT™

Product Specifications

Raw Lumen Output:
3,830

Effective Lumen Output:
2,380

Candela Output:
24,200

Connector/Wiring:
3' Cable with Integrated Connector

Operating Voltage:
9-16V DC

Current Draw:
2.80A @ 12V DC

Standards & Application:

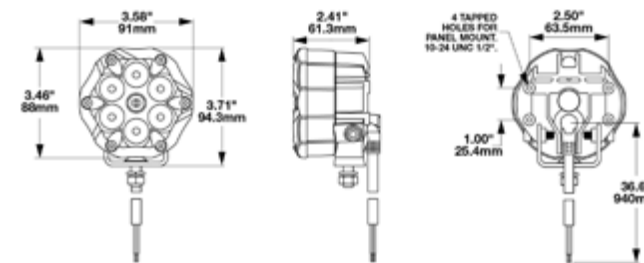

KIT OF 2 OFF-ROAD LIGHTS

PART #	TRAIL 6	DESCRIPTION
0555353	Sport	12V Off-Road Light - Kit of 2

PART #	ACCESSORIES
6600801	Color Monitor, 5", CS-JWS
8001671	Trail 6 Bezel with Side Mount Camera
8001661	Trail 6 Bezel with Center Camera Mount
8200553	Trail 6 Appearance Kit, RED
8200543	Trail 6 Appearance Kit, BLACK
3271561	4 PIN M12 Cable, 10 m
3271571	M12-RCA Conversion Cable
3271581	4 PIN M12 Cable, 6 m

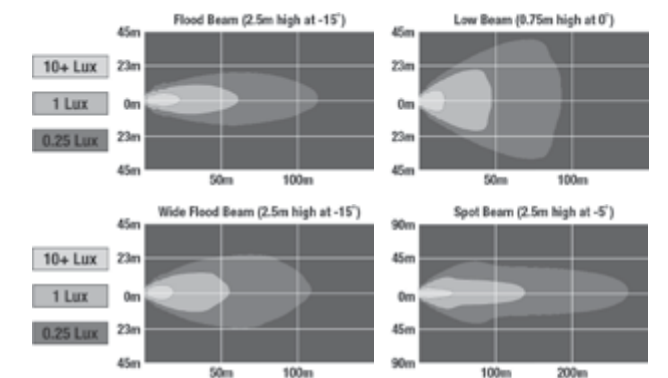

▲ WARNING: Cancer and Reproductive Harm - www.P65Warnings.ca.gov
▲ AVERTISSEMENT: Cancer et effet nocif sur la reproduction - www.P65Warnings.ca.gov

6145 J2 FOG LIGHT



Product Specifications

Raw Lumen Output:
1,080

Effective Lumen Output:
610

Mating Connector:
Packard 12059183; Jeep OEM wire harness

Operating Voltage:
10-15V DC

Current Draw:
1.60A @ 12V DC

Retrofit Information:
4" Round; Jeep Wrangler JK 2007- 2018

Standards & Application:

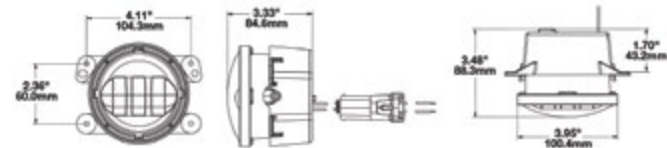

6146 FOG LIGHT



Product Specifications

Raw Lumen Output:
1,080

Effective Lumen Output:
610

Mating Connector:
Packard 12059183

Operating Voltage:
10-15V DC

Current Draw:
1.6A @ 12V DC

Retrofit Information:
4" Round; 2005-2014 Ford F-150s

Standards & Application:

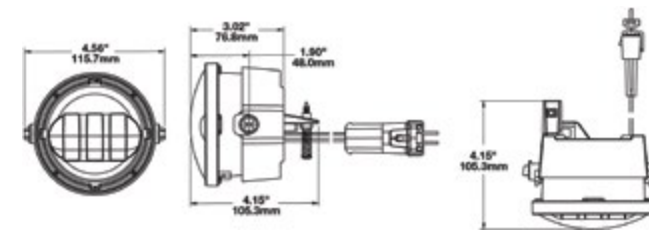

KIT OF 2 JL FOG LIGHTS

PART #	BEZEL	DESCRIPTION
0557983	Black	12V SAE/ECE Jeep JL Fog Light - Kit of 2
0557993	Black	12V SAE/ECE Jeep JL Rubicon Fog Light - Kit of 2
0558003	Black	12V SAE/ECE Jeep JL Sport Fog Light - Kit of 2

KIT OF 2 JK FOG LIGHTS

PART #	BEZEL	DESCRIPTION
0554413	Carbon Fiber	12V SAE/ECE Fog Light - Kit of 2
0554573	Black	12V SAE/ECE Fog Light - Kit of 2

KIT OF 2 FOG LIGHTS

PART #	BEZEL	DESCRIPTION
0549671	Black	12V SAE/ECE Fog Light for 2005-2010 Ford F-150
0549681	Chrome	12V SAE/ECE Fog Light for 2005-2010 Ford F-150
0549651	Black	12V SAE/ECE Fog Light for 2011-2014 Ford F-150
0549661	Chrome	12V SAE/ECE Fog Light for 2011-2014 Ford F-150

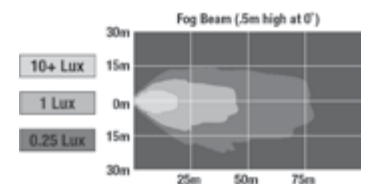

▲ **WARNING:** Cancer and Reproductive Harm - www.P65Warnings.ca.gov
 ▲ **AVERTISSEMENT:** Cancer et effet nocif sur la reproduction - www.P65Warnings.ca.gov

▲ **WARNING:** Cancer and Reproductive Harm - www.P65Warnings.ca.gov
 ▲ **AVERTISSEMENT:** Cancer et effet nocif sur la reproduction - www.P65Warnings.ca.gov



Product Specifications

Raw Lumen Output:
3,200 (High Beam); 1,770 (Low Beam)

Effective Lumen Output:
1,260 (High Beam); 750 (Low Beam)

Candela Output:
71,500 (High Beam); 35,003 (Low Beam)

Connector/Wiring:
H4

Mating Connector:
H4 AMP#172615-2

Operating Voltage:
9-32V DC

Current Draw:
High Beam: 3.5A @ 12V DC; 1.80A @ 24V DC
Low Beam: 2.00A @ 12V DC; 1.10A @ 24V DC

Retrofit Information:
7" Round (PAR56); Jeep Wrangler JK 2007-2018

Standards & Application:

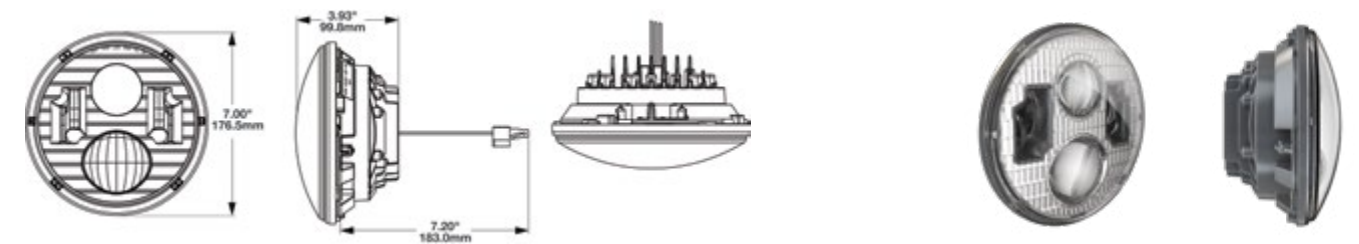

SINGLE HEADLIGHTS

PART # DESCRIPTION

0557661 12-24V DOT High & Low Beam

PART # ACCESSORIES

3156351 Mounting Ring Kit for 7" Round (PAR56) Headlights

8000381 Anti-Flicker Harness H4/H4

⚠ WARNING: Cancer and Reproductive Harm - www.P65Warnings.ca.gov

⚠ AVERTISSEMENT: Cancer et effet nocif sur la reproduction - www.P65Warnings.ca.gov

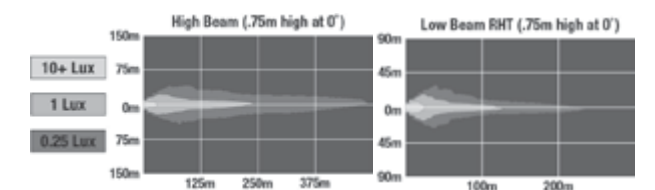

Product Specifications

Raw Lumen Output:
3,200 (High Beam); 1,770 (Low Beam)

Effective Lumen Output:
1,260 (High Beam); 750 (Low Beam)

Candela Output:
71,500 (High Beam); 35,003 (Low Beam)

Connector/Wiring:
H4

Operating Voltage:
9-32V DC

Current Draw:
Heated High Beam: 4.20A @ 12V DC;
2.30A @ 24V DC
High Beam: 3.50A @ 12V DC; 1.80A @ 24V DC
Low Beam: 2.00A @ 12V DC; 1.10A @ 24V DC
Front Position: 0.16A @ 12V DC; 0.10A @ 24V DC
DRL: 1.60A @ 12V DC; 0.80A @ 24V DC

Retrofit Information:
7" Round (PAR56)

Standards & Application:

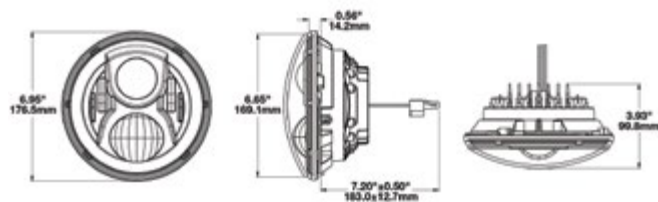

Product Specifications

Raw Lumen Output:
4,170 (High Beam); 2,340 (Low Beam)

Effective Lumen Output:
1,340 (High Beam); 694 (Low Beam)

Candela Output:
84,700 (High Beam); 30,600 (Low Beam)

Connector/Wiring:
H4

Mating Connector:
H4 AMP#172615-2

Operating Voltage:
9-32V DC

Current Draw:
High Beam: 3.60A @ 12V; 1.80A @ 24V DC
Low Beam: 2.00A @ 12V; 1.10A @ 24V DC
Front Position: 0.16A @ 12V; 0.10A @ 24V DC
DRL: 1.60A @ 12V; 0.80A @ 24V DC

Retrofit Information:
7" Round (PAR56)

Standards & Application:

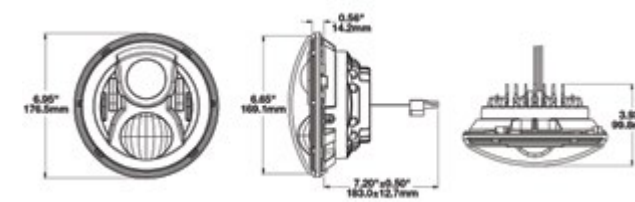

HEATED SINGLE HEADLIGHTS

PART #	BEZEL	DESCRIPTION
0556281	Black	12-24V DOT High & Low Beam
0556291	Chrome	12-24V DOT High & Low Beam
0556301	Black	12-24V ECE/RHT High & Low Beam - FP & DRL
0556311	Chrome	12-24V ECE/RHT High & Low Beam - FP & DRL
0556321	Black	12-24V ECE/LHT High & Low Beam - FP & DRL
0556331	Chrome	12-24V ECE/LHT High & Low Beam - FP & DRL

NON-HEATED SINGLE HEADLIGHTS

PART #	BEZEL	DESCRIPTION
0554941	Black	12-24V DOT High & Low Beam
0554961	Chrome	12-24V DOT High & Low Beam
0554981	Black	12-24V DOT High & Low Beam w/ Mounting Ring
0554991	Chrome	12-24V DOT High & Low Beam w/ Mounting Ring

⚠ **WARNING:** Cancer and Reproductive Harm - www.P65Warnings.ca.gov
⚠ **AVERTISSEMENT:** Cancer et effet nocif sur la reproduction - www.P65Warnings.ca.gov

SINGLE HEADLIGHTS

PART #	BEZEL	DESCRIPTION
0556951	Chrome	12-24V ECE LHT High & Low Beam w/ DRL
0556961	Black	12-24V ECE LHT High & Low Beam w/ DRL
0556971	Chrome	12-24V ECE RHT High & Low Beam w/ DRL
0556981	Black	12-24V ECE RHT High & Low Beam w/ DRL
0557501	Black	12-24V ECE LHT High & Low Beam
0557511	Black	12-24V ECE RHT High & Low Beam

PART # ACCESSORIES

3156351	Mounting Ring Kit for 7" Round (PAR56) Headlights
3266081	Jumper Harness H4/H13
8000311	Anti-Flicker Harness H4/H13

⚠ **WARNING:** Cancer and Reproductive Harm - www.P65Warnings.ca.gov
⚠ **AVERTISSEMENT:** Cancer et effet nocif sur la reproduction - www.P65Warnings.ca.gov

PART # ACCESSORIES

3156351	Mounting Ring Kit for 7" Round (PAR56) Headlights
3266081	Jumper Harness H4/H13
8000381	Anti-Flicker Harness H4/H4
8000311	Anti-Flicker Harness H4/H13
8200411	Wire Harness H4 for 7" Round (PAR56) Headlights

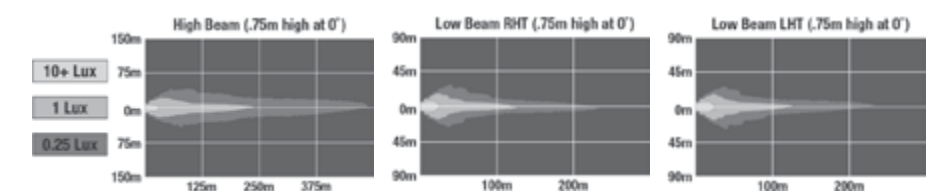
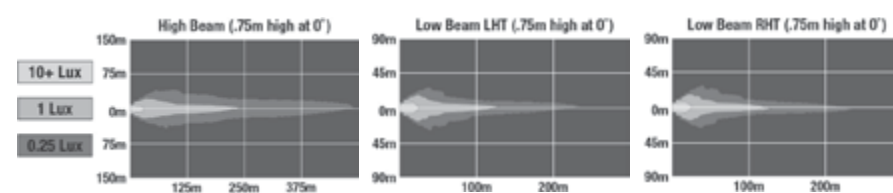

8700 EVOLUTION J2



8800 EVOLUTION 2

Product Specifications

Raw Lumen Output:
3,200 (High Beam); 1,770 (Low Beam)

Effective Lumen Output:
1,260 (High Beam); 750 (Low Beam)

Candela Output:
71,500 (High Beam); 35,003 (Low Beam)

Connector/Wiring:
DOT: H13 Delphi 15326813
ECE: H4

Operating Voltage:
9-16V DC

Current Draw:
High Beam: 4.20A @ 12V DC
Low Beam: 2.00A @ 12V DC
DRL: 1.60A @ 12V DC
Front Position: 0.16A @ 12V DC

Retrofit Information:
7" Round (PAR56); Jeep Wrangler JK 2007-2018

Standards & Application:

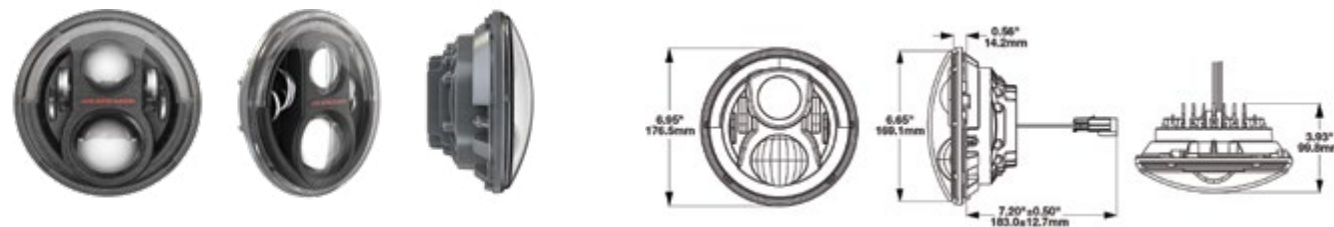

Product Specifications

Raw Lumen Output:
2,250 (High Beam); 2,830 (Low Beam)

Effective Lumen Output:
898 (High Beam); 782 (Low Beam)

Candela Output:
73,200 (High Beam); 29,800 (Low Beam)

Connector/Wiring:
H4 Connector - AMP (#172615-2)

Operating Voltage:
9-32V DC

Current Draw:
Heated: 3.30A @ 12V; 1.67A @ 24V DC
Non-Heated: 2.10A @ 12V; 1.00A @ 24V DC

Retrofit Information:
4" x 6" Rectangle; 1A1 and 2A1 Sealed Beams

Standards & Application:



CHROME HIGH BEAM, HEATED

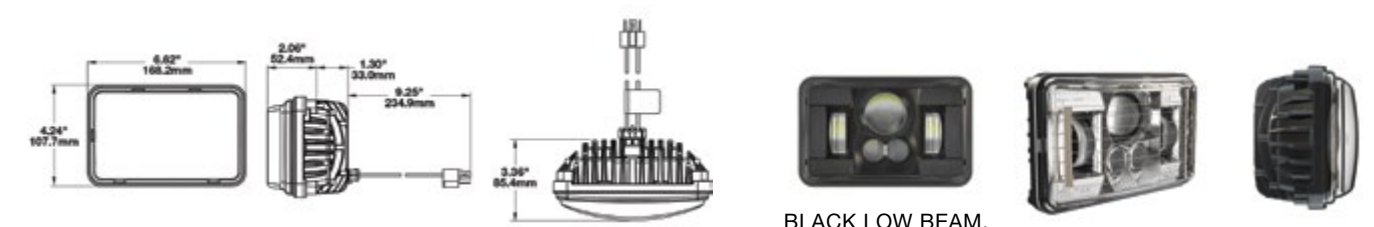

BLACK LOW BEAM, NON-HEATED

KIT OF 2 HEADLIGHTS

PART #	BEZEL	DESCRIPTION
0553973	Carbon Fiber	12V DOT High & Low Beam - Kit of 2
0554543	Black	12V DOT High & Low Beam - Kit of 2
0553983	Carbon Fiber	12V ECE RHT High & Low Beam w/ DRL & FP - Kit of 2
0554553	Black	12V ECE RHT High & Low Beam w/ DRL & FP - Kit of 2
0553993	Carbon Fiber	12V ECE LHT High & Low Beam w/ DRL & FP - Kit of 2
0554563	Black	12V ECE LHT High & Low Beam w/ DRL & FP - Kit of 2

PART #	ACCESSORIES
5868171	RH Single Mounting Ring
5868181	LH Single Mounting Ring
8200461	2017-18 Jeep JK Mounting Ring Kit
8200693	Mounting Kit for Jeep JL
8200691	Single Mounting Ring for Jeep JL

▲ **WARNING:** Cancer and Reproductive Harm - www.P65Warnings.ca.gov
▲ **AVERTISSEMENT:** Cancer et effet nocif sur la reproduction - www.P65Warnings.ca.gov

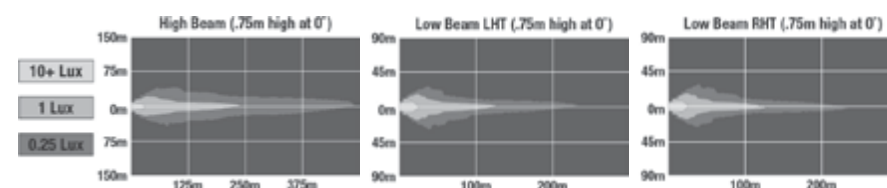

HEATED SINGLE HEADLIGHTS

PART #	BEZEL	DESCRIPTION
0552651	Black	12-24V DOT/ECE RHT Heated Low Beam
0551771	Chrome	12-24V DOT/ECE RHT Heated Low Beam
0552661	Black	12-24V ECE LHT Low Heated Beam
0552091	Chrome	12-24V ECE LHT Low Heated Beam
0552671	Black	12-24V DOT ECE High Heated Beam
0551781	Chrome	12-24V DOT ECE High Heated Beam

PART # ACCESSORIES

3269601	Low Beam Harness for 8800 Evo 2
3269611	High Beam Harness for 8800 Evo 2

NON-HEATED SINGLE HEADLIGHTS

PART #	BEZEL	DESCRIPTION
0552551	Black	12-24V DOT/ECE RHT Low Beam
0551371	Chrome	12-24V DOT/ECE RHT Low Beam
0552561	Black	12-24V ECE LHT Low Beam
0551391	Chrome	12-24V ECE LHT Low Beam
0552571	Black	12-24V DOT ECE High Beam
0551381	Chrome	12-24V DOT ECE High Beam

▲ **WARNING:** Cancer and Reproductive Harm - www.P65Warnings.ca.gov
▲ **AVERTISSEMENT:** Cancer et effet nocif sur la reproduction - www.P65Warnings.ca.gov

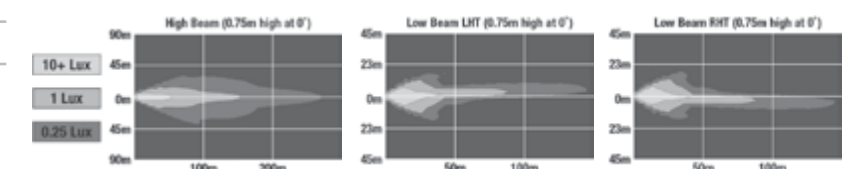



Product Specifications

Raw Lumen Output:
2,640 (High Beam); 2,250 (Low Beam)

Effective Lumen Output:
1,200 (High Beam); 975 (Low Beam)

Connector/Wiring:
H4

Operating Voltage:
10-32V DC

Current Draw:
High Beam: 1.94A @ 12V DC; 1.03A @ 24V DC
Low Beam: 1.67A @ 12V DC; 0.87A @ 24V DC
Front Position: 0.22A @ 12V DC; 0.16A @ 24V DC

Retrofit Information:
5" x 7" Rectangle; 2B1 Sealed Beams

Standards & Application:

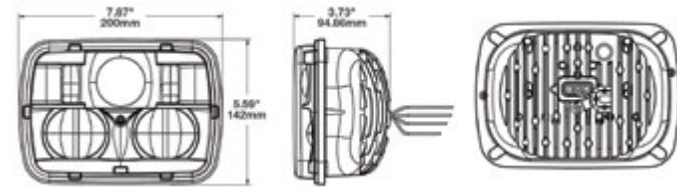

Product Specifications

Raw Lumen Output:
3,015 (High Beam); 2,250 (Low Beam)

Effective Lumen Output:
1,320 (High Beam); 975 (Low Beam)

Connector/Wiring:
H4

Operating Voltage:
10-32V DC

Current Draw:
High Beam: 5.35A @ 12V DC; 2.50A @ 24V DC
Low Beam: 4.30A @ 12V DC; 2.10A @ 24V DC
Front Position: 2.80A @ 12V DC; 1.32A @ 24V DC

Retrofit Information:
5" x 7" Rectangle; 2B1 Sealed Beams

Standards & Application:

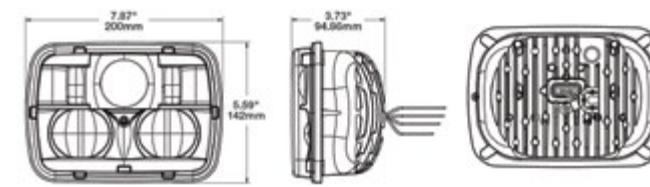

SINGLE HEADLIGHTS

PART #	BEZEL	DESCRIPTION
0554491	Black	12-24V DOT/ECE RHT High & Low Beam w/ FP
0554471	Chrome	12-24V DOT/ECE RHT High & Low Beam w/ FP
0554451	Black	12-24V ECE LHT High & Low Beam w/ FP
0554431	Chrome	12-24V ECE LHT High & Low Beam w/ FP

PART #	ACCESSORIES
8000381	H4/H4 Anti-Flicker Harness

⚠ WARNING: Cancer and Reproductive Harm - www.P65Warnings.ca.gov
⚠ AVERTISSEMENT: Cancer et effet nocif sur la reproduction - www.P65Warnings.ca.gov

If your vehicle is operated in the United States you do NOT need to connect the Front Position wire (red) unless your vehicle is equipped with a front position light.

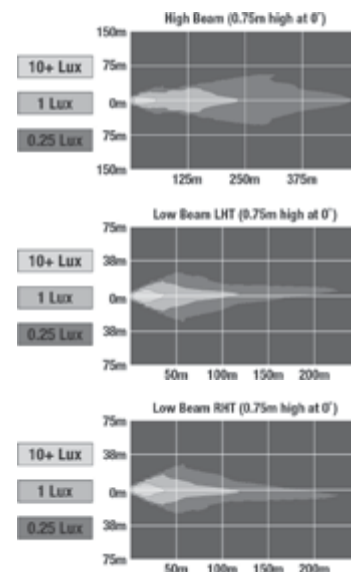

HEATED SINGLE HEADLIGHTS

PART #	BEZEL	DESCRIPTION
0554461	Chrome	12-24V DOT/ECE RHT Heated High & Low Beam w/ FP
0554481	Black	12-24V DOT/ECE RHT Heated High & Low Beam w/ FP
0554421	Chrome	12-24V ECE LHT Heated High & Low Beam w/ FP
0554441	Black	12-24V ECE LHT Heated High & Low Beam w/ FP

PART #	ACCESSORIES
8000381	H4/H4 Anti-Flicker Harness

⚠ WARNING: Cancer and Reproductive Harm - www.P65Warnings.ca.gov
⚠ AVERTISSEMENT: Cancer et effet nocif sur la reproduction - www.P65Warnings.ca.gov

If your vehicle is operated in the United States you do NOT need to connect the Position wire (red) unless your vehicle is equipped with a front position light.

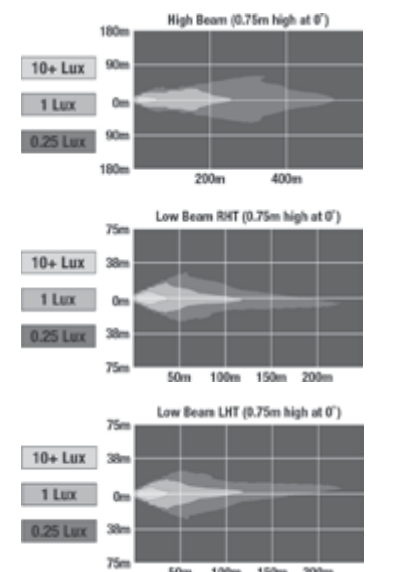



POWERSPORTS

Products featured: Model 8700 Evo 2 Dual Burn, Models Trail 6 Pro® and Trail 6 Sport®, and Model 8690 Adaptive 2®

THE ADAPTIVE® 2 SERIES



Since launching the world's first dynamically Adaptive Motorcycle Headlight in June 2016, J.W. Speaker has improved their adaptive technology to utilize the high beam in conjunction with the low beam. This improvement provides ditch-to-ditch lighting and a punch of light 1,500 feet down the road, eliminating dark corners on sharp turns and delivering a safer, more confident experience for the rider.

The Adaptive® 2 Series uses on-board sensors to calculate angles on a real-time basis, automatically directing the light as the motorcycle leans. This additional illumination fills the dark areas that other headlights cannot when cornering to maximize the rider's visibility.

With this advanced technology, J.W. Speaker has solved a visibility issue that current aftermarket and OEM motorcycle headlights are not able to address, delivering a technological breakthrough that dramatically improves rider comfort and safety. Additionally, the Adaptive 2 Series are offered at a reduced price, making the latest in lighting technology and safety more affordable!

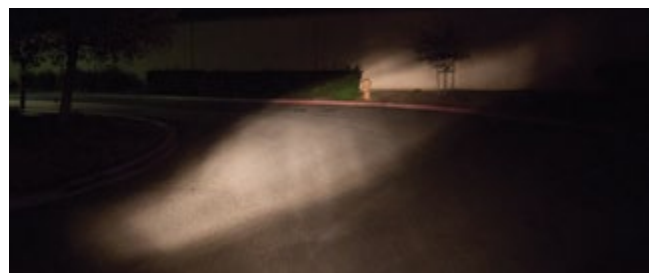

DARK VOID



BRIGHT ILLUMINATION

Adaptive® Headlights = Exceptional Visibility

These Adaptive® 2 headlights are designed with an integrated optical system that includes both an adaptive low beam as well as our proprietary ComfortLite® high beam. Together, these optics provide best-in-class foreground illumination and light above the horizon that dramatically improves operator comfort and safety for night-time driving.

Easy Install For Over 1,000 Different Motorcycles

Retrofitting LED headlights into certain motorcycle buckets can present a challenge for some motorcycles. The added length of the headlight is commonly too deep to fit the OEM bucket, requiring modification.

DYNAMIC PLATFORM RESPONDS IN REAL TIME



HIGH BEAM

LOW BEAM

LEANING LEFT

LEANING RIGHT

The Adaptive® 2 Series headlights use on-board sensors and advanced electronics to calculate bank angles on a real time basis, automatically directing the light array up or down as the motorcycle leans. This additional illumination fills the gaps that your stock headlight can't when cornering at night. This adaptive headlight intelligently "tunes" high beam, low beam, and banking optics in a way that maximizes visibility in corners.

TRAIL 6™



Experience the Control

You need reliable, bright lights that are as tough as the trails you ride. Easily mount the unstoppable Trail 6 Sport anywhere to light up the trails with over 2,300 Effective Lumens of bright white light.

Experience the Science

When you're blazing the trails you need a light to tell others when you're slowing down—before you even touch the brakes. The deceleration-sensing Trail 6 Flash will make you stand out for style and safety with added seconds of warning to other drivers.

Experience it All

View every trail with wide-range visibility, taking fun and safety to the next level. Elevate your Trail 6 with our compact and high-quality camera. Designed to fit any Trail 6 with your choice of a Side or Center Bezel.



TRAIL 6

PRODUCT SPECIFICATIONS

Raw Lumen Output:

Sport: 3,830
Flash: 690

Effective Lumen Output:

Sport: 2,380
Flash: 330

Candela Output:

Sport: 24,200
Flash: 10,000

Connector/Wiring:

Sport: 3' Cable w/ Integrated Connector
Flash: Integrated Connector Harness

Operating Voltage:

Sport: 9-16V DC
Flash: 10-15V DC

Current Draw:

Sport: 2.80A @ 12V DC
Flash: 0.87A @ 12V DC

Standards & Application:



CENTER CAMERA MOUNT

SIDE CAMERA MOUNT



RED APPEARANCE KIT

SPORT, HIGH BEAM

SPORT, LOW BEAM

SPORT, WHITE LIGHT

5" COLOR MONITOR

FLASH, LOW BEAM

FLASH, HIGH BEAM

FLASH, LIGHTS OFF

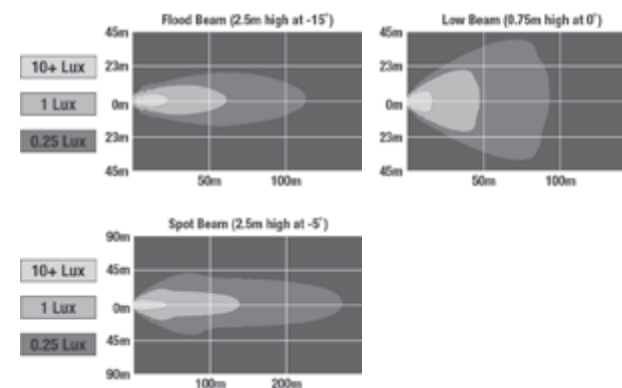
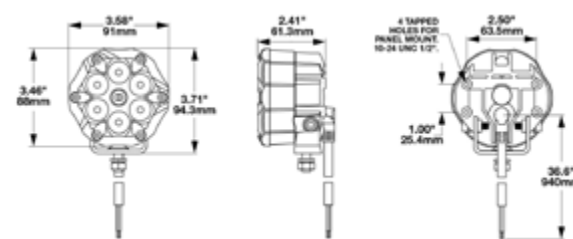

KIT OF 2 OFF-ROAD LIGHTS

PART #	TRAIL 6	DESCRIPTION
0555353	Sport	12V Off-Road Lights
0555363	Flash	12V Off-Road Safety & Warning Lights

PART # ACCESSORIES

6600801	Color Monitor, 5", CS-JWS, M12
8001671	Trail 6 Bezel with Side Mount Camera
8001661	Trail 6 Bezel with Center Camera Mount
8200573	Trail 6 JK Turn Signal Bracket Kit
8200553	Trail 6 Red Appearance Kit, 2 Bezel Rings & Inner Bezels
8200543	Trail 6 Black Appearance Kit, 2 Bezel Rings
3271561	4 PIN M12 Cable, 10 m
3271571	M12-RCA Conversion Cable
3271581	4 PIN M12 Cable, 6 m



▲ **WARNING:** Cancer and Reproductive Harm - www.P65Warnings.ca.gov
▲ **AVERTISSEMENT:** Cancer et effet nocif sur la reproduction - www.P65Warnings.ca.gov

NEW 5-IN-1 93



All New 5-in-1 Headlight

J.W. Speaker's LED Model 93 lights are the new standard for 90mm lights, providing a drop-in replacement or pedestal mounts for original equipment manufacturers (OEMs), up-fitters, vehicle fleets, and individuals looking for the best-performing LED lights. Engineered as a 5-in-1 LED headlight, the Model 93 offers Low Beam, High Beam, Daytime Running Light (DRL), Front Position, and Turn Signal functionality all in one light. The headlight offers many applications for a variety of vehicles suited for agriculture, automotive, construction, industrial, material handling, mining, motorcycle, off-road 4x4, railroad, specialty vehicles, and truck and bus.

PRODUCT SPECIFICATIONS

- Raw Lumen Output:**
630 (High Beam); 1,910 (Low Beam)
- Effective Lumen Output:**
230 (High Beam); 575 (Low Beam)
- Candela Output:**
45,000 (High Beam); 18,500 (Low Beam)
- Connector/Wiring:**
High Beam: Deutsch DT04-3P
Low Beam: Deutsch DT04-2P
- Operating Voltage:**
10-31V DC
- Current Draw:**
Low Beam: 1.97A @ 12V
High Beam: 0.80A @ 12V
Front Position: 0.40A @ 12V
DRL: 1.33A @ 12V
- Retrofit Information:**
Standard 90mm lamps

Standards & Application:

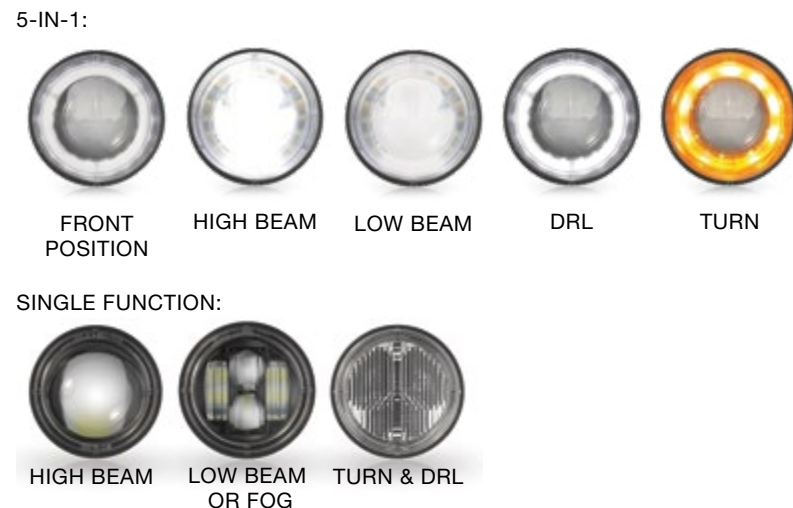

SINGLE HEADLIGHTS

BEAM PATTERNS

3-POINT MOUNT

PART #	DESCRIPTION	LOW BEAM	HIGH BEAM	DRL	FP	DI	1.5mm	3mm
0560371	12-24V DOT/ECE R112 RHT 5-in-1 Headlight	X	X	X	X	X		X
0560381	12-24V ECE R112 LHT 5-in-1 Headlight	X	X	X	X	X		X
0560391	12V SAE/DOT Motorcycle Headlight	X	X		X			X
0560401	12V DOT/ECE R113 Motorcycle Headlight	X	X	X	X			X
0554381	12-24V DOT/ECE High Beam Headlight with FP		X		X		X	X
0553071	12-24V DOT/ECE High Beam Headlight		X				X	X
0553091	12-24V ECE R112 LHT Low Beam Headlight	X					X	X
0553101	12-24V DOT/ECE R112 RHT Low Beam Headlight	X					X	X
0553081	12-24V DOT/ECE R113 Agriculture Low Beam Headlight	X					X	X
0556701	12-24V SAE/ECE Fog Light						X	X
0347941	12-24V SAE/ECE Turn Signal & DRL			X		X	X	X

For parts offered in bulk quantities, please visit the J.W. Speaker website.

MOUNTING OPTIONS

PART #	DESCRIPTION	APPLICATION
8001461	3-point Mount for 1.5mm Mounting Frame	See Above
8001471	3-point Mount for 3mm Mounting Frame	See Above
8201021	3-Point Lock Mount for 3mm Mounting Frame	See Above
8001621	Double Lamp Pedestal Mounting Bracket	Any Light
8001601	Single Lamp Pedestal Mounting Bracket	Any Light
8001211	Motorcycle Bar Mount Kit w/ Wiring Harness - Large	See Above
8001221	Motorcycle Bar Mount Kit w/ Wiring Harness - Small	See Above
0700001	Motorcycle Bar Mount Kit - 20-24mm	See Above
0700011	Motorcycle Bar Mount Kit - 25-29mm	See Above

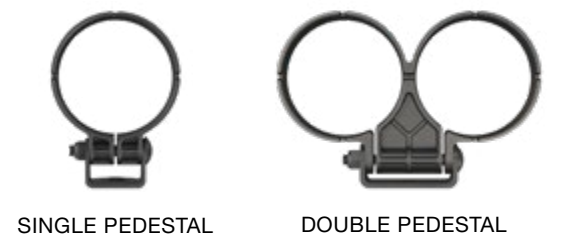

WARNING: Cancer and Reproductive Harm - www.P65Warnings.ca.gov
AVERTISSEMENT: Cancer et effet nocif sur la reproduction - www.P65Warnings.ca.gov

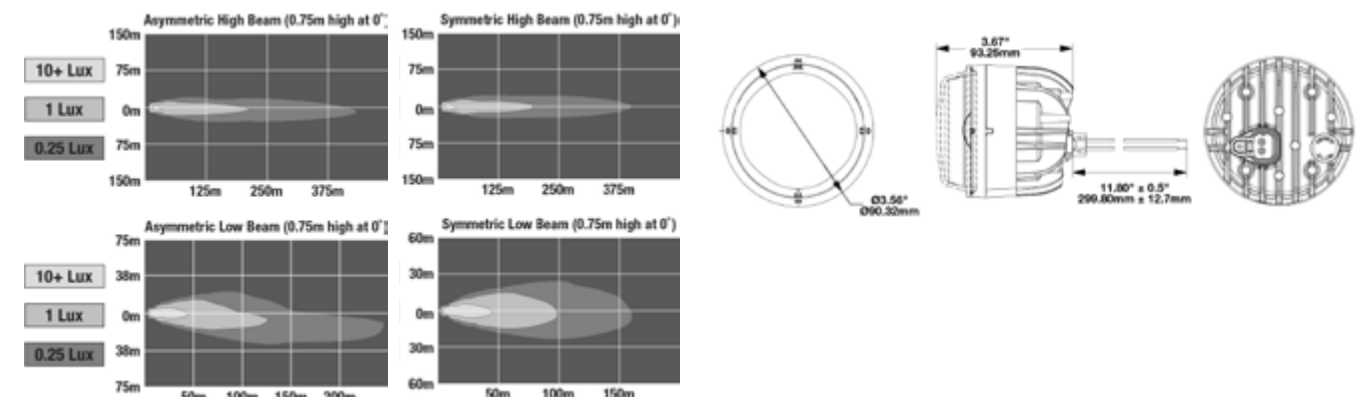

These Model 93 part numbers and specifications are specific to the Powersport market. To view other parts under this model, please see the Transport and Industrial market sections.



Product Specifications

Raw Lumen Output:
1,800 (High Beam); 1,600 (Low Beam)

Effective Lumen Output:
497 (High Beam); 321 (Low Beam)

Candela Output:
41,800 (High Beam); 14,600 (Low Beam)

Connector/Wiring:
Deutsch DT04-4P

Operating Voltage:
10-32V DC

Current Draw:
High Beam: 1.8A @ 12V DC; 1.0A @ 24V DC
Low Beam: 1.5A @ 12V DC; 0.8A @ 24V DC
FP: 0.1A @ 12V DC; 0.06A @ 24V DC

Retrofit Information:
Standard 100mm Bi-LED Headlight

Standards & Application:

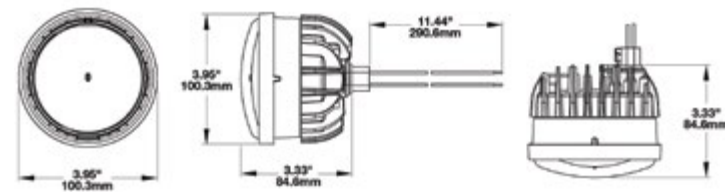

Product Specifications

Raw Lumen Output:
346

Effective Lumen Output:
291

Candela Output:
12,300

Connector/Wiring:
Packard 12059450-B

Operating Voltage:
9-16V DC

Current Draw:
0.83A @ 10V DC; 0.70A @ 12V DC

Retrofit Information:
4.5" Round (PAR36)

Standards & Application:

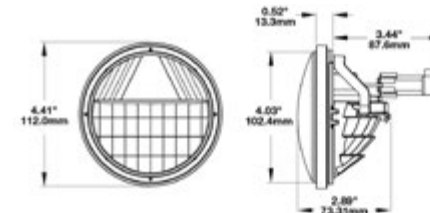

SINGLE HEADLIGHTS

PART #	DESCRIPTION
0554911	12-24V ECE LHT High & Low Beam (Reg 112)
0554921	12-24V DOT/ECE High & Low Beam (Reg 113)

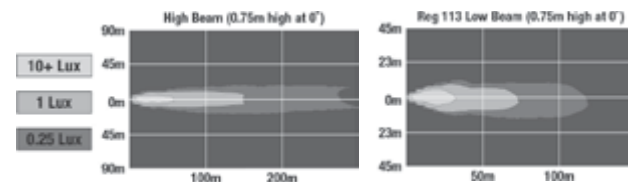

PART # ACCESSORIES

8001521	Single Light Pedestal Mount Bracket
8001511	3-Point Mount for 3mm Mounting Frame

▲ **WARNING:** Cancer and Reproductive Harm - www.P65Warnings.ca.gov
▲ **AVERTISSEMENT:** Cancer et effet nocif sur la reproduction - www.P65Warnings.ca.gov



KIT OF 2 FOG LIGHTS

PART #	DESCRIPTION
0553023	12V SAE/ECE RHT & LHT Reflector Fog Light - Kit of 2

SINGLE FOG LIGHT

PART #	DESCRIPTION
0553021	12V SAE/ECE RHT & LHT Reflector Fog Light

▲ **WARNING:** Cancer and Reproductive Harm - www.P65Warnings.ca.gov
▲ **AVERTISSEMENT:** Cancer et effet nocif sur la reproduction - www.P65Warnings.ca.gov

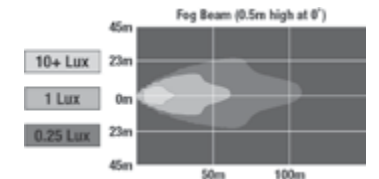

6045 FOG LIGHT



Product Specifications

Raw Lumen Output:
750

Effective Lumen Output:
500

Connector/Wiring:
Packard (#12059450-B)

Operating Voltage:
9-18V DC

Current Draw:
0.75A @ 12V DC

Retrofit Information:
4.5" Round (PAR36)

Standards & Application:

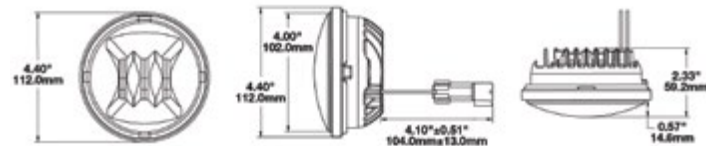

KIT OF 2 FOG LIGHTS

PART #	BEZEL	DESCRIPTION
0551593	Chrome	12V SAE/ECE Fog Light - Kit of 2
0551583	Black	12V SAE/ECE Fog Light - Kit of 2
0551653	Chrome	12V SAE/ECE RHT Fog Light with Mounting Assembly

PART #	ACCESSORIES
8200181	Mounting Assembly Adapter Kit

WARNING: Cancer and Reproductive Harm - www.P65Warnings.ca.gov
AVERTISSEMENT: Cancer et effet nocif sur la reproduction - www.P65Warnings.ca.gov

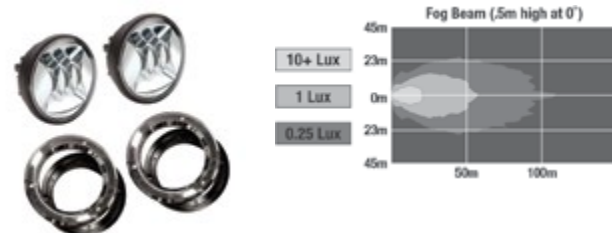

KIT WITH MOUNTING ASSEMBLY

SINGLE FOG LIGHTS

PART #	BEZEL	DESCRIPTION
0546161	Chrome	12V SAE/ECE RHT Fog Light
0545731	Black	12V SAE/ECE RHT Fog Light

6130 EVOLUTION

Product Specifications

Raw Lumen Output:
2,230 (High Beam); 1,330 (Low Beam);

Effective Lumen Output:
840 (High Beam); 440 (Low Beam);

Connector/Wiring:
12" Bare Wires

Operating Voltage:
10-30V DC

Current Draw:
High Beam: 3.00A @ 12V DC; 1.43A @ 24V DC
Low Beam: 2.30A @ 12V DC; 1.01A @ 24V DC
FP: 0.12A @ 12V DC; 0.09A @ 24V DC

Retrofit Information:
4.75" Round

Standards & Application:

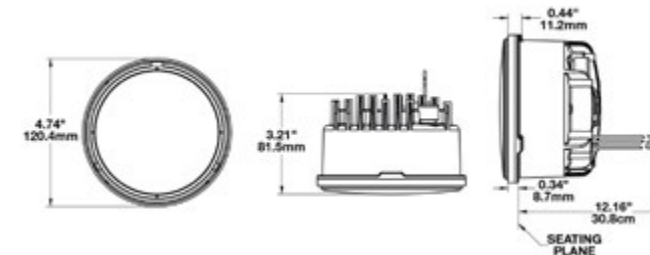

HIGH & LOW BEAM



SINGLE HEADLIGHTS

PART #	DESCRIPTION
0549881	12-24V DOT/ECE RHT LED High & Low Beam w/ FP
0549891	12-24V ECE LHT LED High & Low Beam w/ FP

If your vehicle is operated in the United States you do NOT need to connect the Front Position wire (red) unless your vehicle is equipped with a front position light.

WARNING: Cancer and Reproductive Harm - www.P65Warnings.ca.gov
AVERTISSEMENT: Cancer et effet nocif sur la reproduction - www.P65Warnings.ca.gov

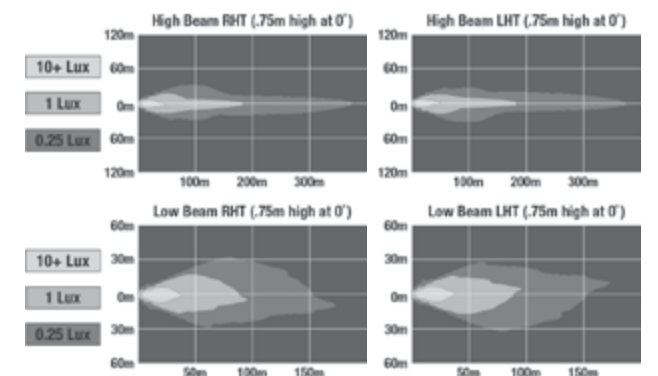



ADJUSTABLE MOUNT

Product Specifications

Raw Lumen Output:
1,075 (High Beam); 430 (Low Beam)

Effective Lumen Output:
720 (High Beam); 240 (Low Beam)

Mating Connector:
SAE/ECE: PE 12110293
SAE: Packard 12124817
DOT: APTIV (Delphi) 12162144

Operating Voltage:
10-30V DC

Current Draw*:
High Beam: 1.14A @ 12V DC; 0.57A @ 24V DC
Low Beam: 0.41A @ 12V DC; 0.22A @ 24V DC
* For the full listing of Current Draws, please visit the respective Product Number's Specification Sheet on our website at www.jwspeaker.com

Retrofit Information:
4.5" Round (PAR36)

Standards & Application:



FIXED MOUNT FIXED MOUNT, LOW BEAM

ADJUSTABLE MOUNT

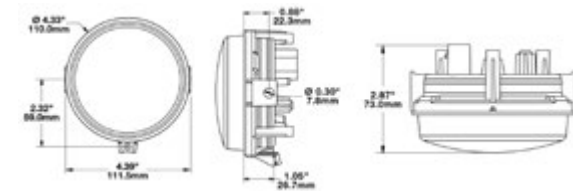

Product Specifications

Raw Lumen Output:
1,620 (High Beam); 925 (Low Beam)

Effective Lumen Output:
850 (High Beam); 500 (Low Beam)

Candela Output:
41,000 (High Beam); 12,110 (Low Beam)

Connector/Wiring:
H4

Operating Voltage:
9-16V DC

Current Draw:
High Beam: 2.67A @ 12V DC
Low Beam: 1.67A @ 12V DC
Front Position: 0.13A @ 12V DC

Retrofit Information:
5.75" Round (PAR46)

Standards & Application:



DARK CHROME

CHROME

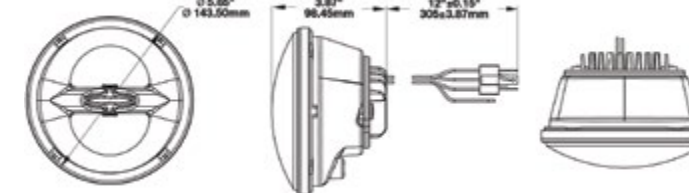

SINGLE HEADLIGHTS

PART #	MOUNT	DESCRIPTION
0551191	Adjustable	12-24V SAE/ECE High & Low Beam w/ Xenoy Housing
0551761	Fixed	12-24V SAE/ECE High & Low Beam w/ Xenoy Housing
0552031	Adjustable	12-24V SAE/ECE High & Low Beam Light w/ Polycarbonate Housing - UL Version
0556421	Fixed	12-24V SAE Low Beam ATV Headlight
0556431	Adjustable	12-24V SAE Low Beam ATV Headlight
0558361	Adjustable	12-24V DOT Low Beam/Front Position w/ Built in Turn Signal

If your vehicle is operated in the United States you do NOT need to connect the Front Position wire (red) unless your vehicle is equipped with a front position light.

⚠ WARNING: Cancer and Reproductive Harm - www.P65Warnings.ca.gov
⚠ AVERTISSEMENT: Cancer et effet nocif sur la reproduction - www.P65Warnings.ca.gov

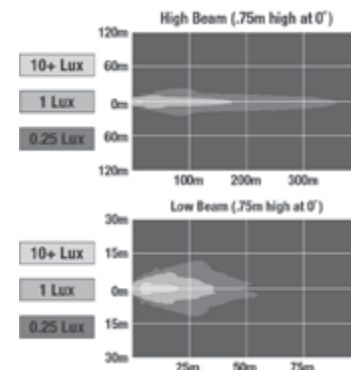

SINGLE HEADLIGHTS

PART #	BEZEL	DESCRIPTION
0553011	Chrome	12V DOT/ECE High & Low Beam Reflector Headlight
0555931	Dark Chrome	12V DOT/ECE High & Low Beam Reflector Headlight

For fitment information visit: www.jwspeaker.com/garage

⚠ WARNING: Cancer and Reproductive Harm - www.P65Warnings.ca.gov
⚠ AVERTISSEMENT: Cancer et effet nocif sur la reproduction - www.P65Warnings.ca.gov

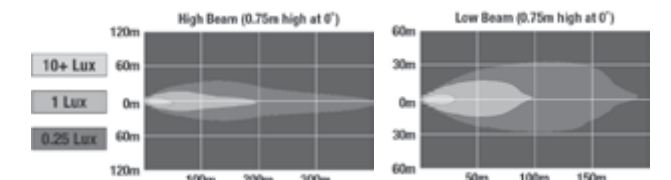

If your bike is operated in the United States you do NOT need to connect the Front Position wire (red) unless your bike is equipped with a front position light.

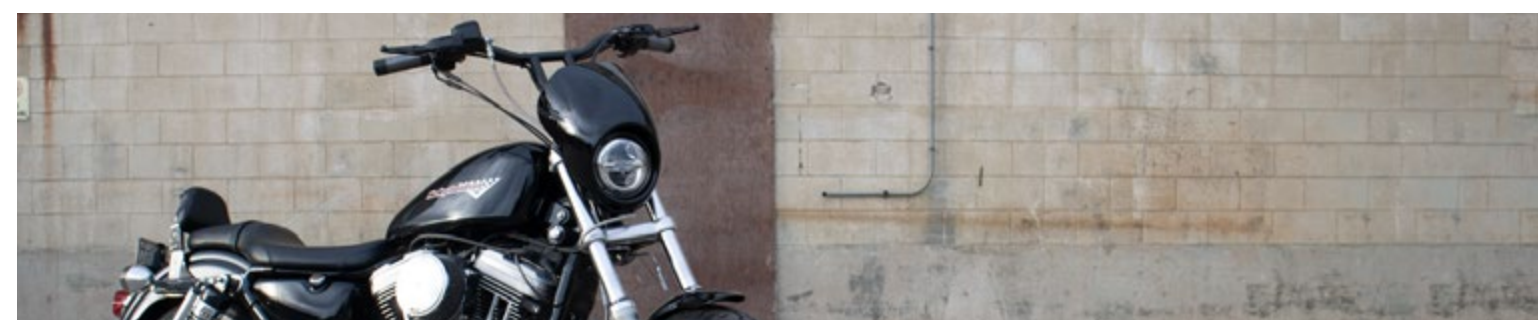



Product Specifications

Raw Lumen Output:
3,360 (High Beam); 2,240 (Low Beam)

Effective Lumen Output:
1,260 (High Beam); 870 (Low Beam)

Mating Connector:
Deutsch DT06-6S

Operating Voltage:
9-16V DC

Current Draw*:
Low Beam: 2.5A @ 13.5V DC;
High Beam: 2.6A @ 13.5V DC;
Front Position: 0.4A @ 13.5V DC;
Low Beam at Full Lean: 3.6A @ 13.5V DC;
High Beam at Full Lean: 4.5A @ 13.5V DC

Standards & Application:



HONDA GROM DUCATI MONSTER YAMAHA FZ-07

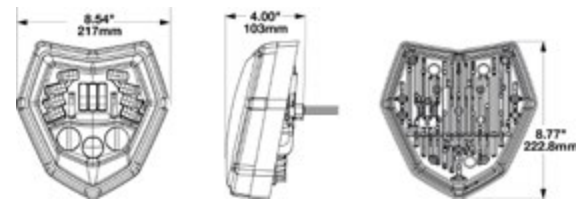

Product Specifications

Raw Lumen Output:
3,200 (High Beam); 1,770 (Low Beam)

Effective Lumen Output:
1,260 (High Beam); 750 (Low Beam)

Candela Output:
71,500 (High Beam); 35,003 (Low Beam)

Connector/Wiring:
H4

Operating Voltage:
9-32V DC

Current Draw:
High Beam: 3.5A @ 12V DC; 1.8A @ 24V DC
Low Beam: 2.0A @ 12V DC; 1.1A @ 24V DC

Retrofit Information:
7" Round (PAR56)

Standards & Application:

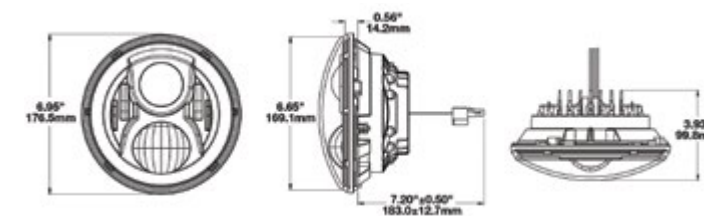

SINGLE ADAPTIVE HEADLIGHTS

PART #	BRACKET	DESCRIPTION
0561843	Honda Grom	12V DOT LED High & Low Beam Adaptive Headlight with Front Position
0561903	Ducati Monster	12V DOT LED High & Low Beam Adaptive Headlight with Front Position
0561923	Yamaha FZ-07	12V DOT LED High & Low Beam Adaptive Headlight with Front Position

For fitment information visit: www.jwspeaker.com/garage

▲ **WARNING:** Cancer and Reproductive Harm - www.P65Warnings.ca.gov
▲ **AVERTISSEMENT:** Cancer et effet nocif sur la reproduction - www.P65Warnings.ca.gov

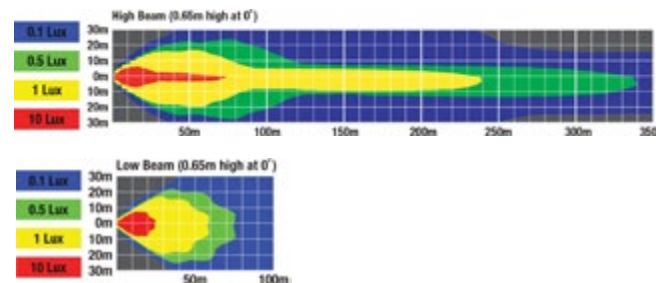

SINGLE HEADLIGHTS

PART #	BEZEL	DESCRIPTION
0554941	Black	12-24V DOT High & Low Beam
0554961	Chrome	12-24V DOT High & Low Beam
0554981	Black	12-24V DOT High & Low Beam w/ Mounting Ring Kit
0554991	Chrome	12-24V DOT High & Low Beam w/ Mounting Ring Kit

For fitment information visit: www.jwspeaker.com/garage

PART # ACCESSORIES

3156351	Mounting Ring Kit for 7" Round (PAR56) Headlights
8200411	H4 Wire Harness Kit 2014 & Newer Harley Bikes

▲ **WARNING:** Cancer and Reproductive Harm - www.P65Warnings.ca.gov
▲ **AVERTISSEMENT:** Cancer et effet nocif sur la reproduction - www.P65Warnings.ca.gov

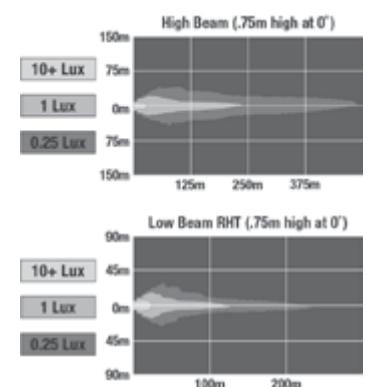

Product Specifications

Raw Lumen Output:
4,170 (High Beam); 2,340 (Low Beam)

Effective Lumen Output:
1,340 (High Beam); 694 (Low Beam)

Candela Output:
84,700 (High Beam); 30,600 (Low Beam)

Connector/Wiring:
H4

Operating Voltage:
9-32V DC

Current Draw:
High Beam: 3.60A @ 12V DC; 1.80A @ 24V DC
Low Beam: 2.00A @ 12V DC; 1.10A @ 24V DC
FP: 0.16A @ 12V DC; 0.10A @ 24V DC
DRL: 1.60A @ 12V DC; 0.80A @ 24V DC

Retrofit Information:
7" Round (PAR56)

Standards & Application:

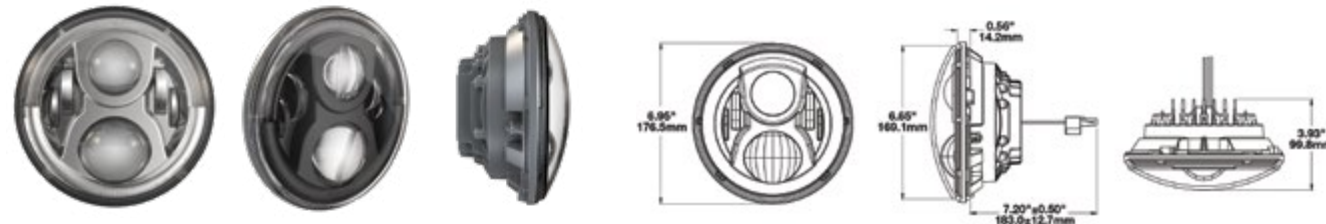

Product Specifications

Raw Lumen Output:
1,620 (High Beam); 925 (Low Beam)

Effective Lumen Output:
850 (High Beam); 500 (Low Beam)

Candela Output:
41,000 (High Beam); 12,110 (Low Beam)

Connector/Wiring:
H4

Operating Voltage:
9-16V DC

Current Draw:
Front Position: 2.67A @ 12V DC
Low Beam: 1.67A @ 12V DC
Front Position: 0.13A @ 12V DC

Retrofit Information:
7" Round (PAR56)

Standards & Application:



SINGLE HEADLIGHTS

PART #	BEZEL	DESCRIPTION
0556961	Black	12-24V ECE LHT High & Low Beam w/ DRL & FP
0556951	Chrome	12-24V ECE LHT High & Low Beam w/ DRL & FP
0556981	Black	12-24V ECE RHT High & Low Beam w/ DRL & FP
0556971	Chrome	12-24V ECE RHT High & Low Beam w/ DRL & FP
0557501	Black	12-24V ECE LHT High & Low Beam
0557511	Black	12-24V ECE RHT High & Low Beam

For fitment information visit: www.jwspeaker.com/garage

▲ **WARNING:** Cancer and Reproductive Harm - www.P65Warnings.ca.gov
▲ **AVERTISSEMENT:** Cancer et effet nocif sur la reproduction - www.P65Warnings.ca.gov

PART #	ACCESSORIES
3156351	Mounting Ring Kit for 7" Round (PAR56) Headlights
8200411	H4 Wire Harness Kit 2014 & Newer Harley Bikes

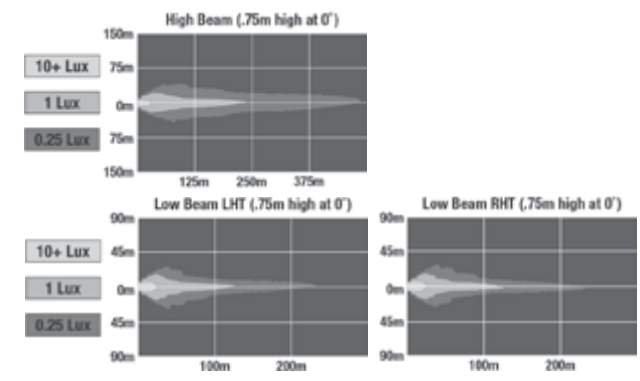

SINGLE HEADLIGHTS

PART #	BEZEL	DESCRIPTION
0552861	Chrome	12V DOT/ECE High & Low Beam Reflector Headlight
0555921	Dark Chrome	12V DOT/ECE High & Low Beam Reflector Headlight

For fitment information visit: www.jwspeaker.com/garage

If your bike is operated in the United States you do NOT need to connect the Front Position wire (red) unless your bike is equipped with a front position light.

PART #	ACCESSORIES
8200411	Wire Harness H4 for 7" Round (PAR56) Headlights

▲ **WARNING:** Cancer and Reproductive Harm - www.P65Warnings.ca.gov
▲ **AVERTISSEMENT:** Cancer et effet nocif sur la reproduction - www.P65Warnings.ca.gov

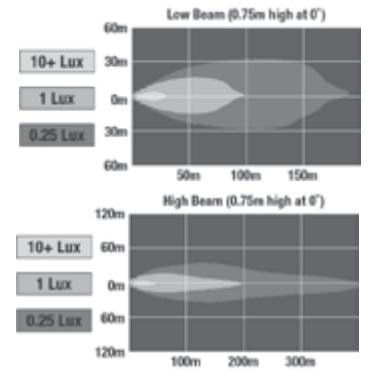



Product Specifications

Raw Lumen Output:
3,520 (High Beam); 2,120 (Low Beam)

Effective Lumen Output:
1,600 (High Beam); 1,050 (Low Beam)

Candela Output:
60,000 (High Beam); 8,300 (Low Beam)

Connector/Wiring:
H4

Operating Voltage:
9-16V DC

Current Draw:
Low Beam: 1.9A @ 12V DC
High Beam: 3.2A @ 12V DC
Front Position: 0.21A @ 12V DC
Low Beam at Full Lean: 4.2A @ 12V DC
High Beam at Full Lean: 5.5A @ 12V DC

Retrofit Information:
5.75" Round (PAR46)

Standards & Application:

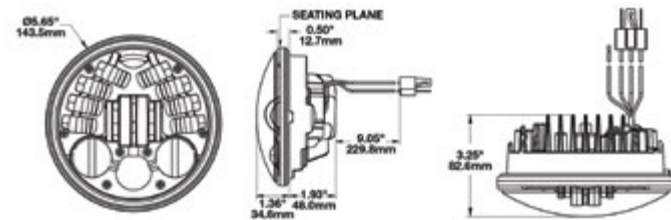
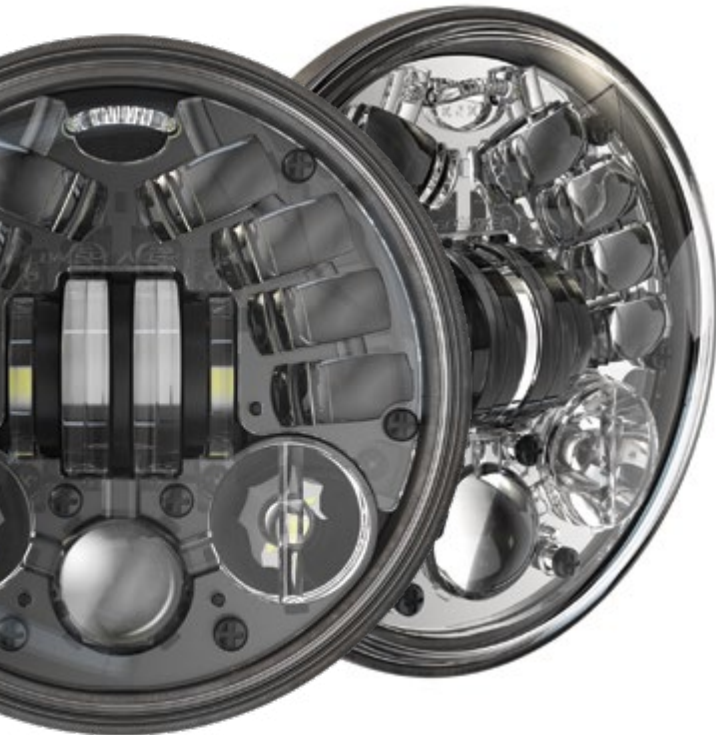

SINGLE HEADLIGHTS

PART #	BEZEL	DESCRIPTION
0555091	Black	12V DOT/ECE High & Low Beam
0555101	Chrome	12V DOT/ECE High & Low Beam

For fitment information visit: www.jwspeaker.com/garage

If your bike is operated in the United States you do NOT need to connect the Front Position wire (red) unless your bike is equipped with a front position light.

⚠ WARNING: Cancer and Reproductive Harm - www.P65Warnings.ca.gov
⚠ AVERTISSEMENT: Cancer et effet nocif sur la reproduction - www.P65Warnings.ca.gov

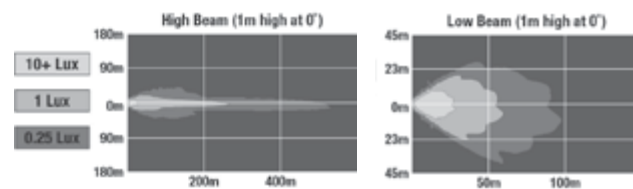

Product Specifications

Raw Lumen Output:
3,520 (High Beam); 2,120 (Low Beam)

Effective Lumen Output:
1,600 (High Beam); 1,050 (Low Beam)

Candela Output:
60,000 (High Beam); 8,300 (Low Beam)

Connector/Wiring:
Bare Leads

Operating Voltage:
9-16V DC

Current Draw:
Low Beam: 1.9A @ 12V DC
High Beam: 3.2A @ 12V DC
Front Position: 0.21A @ 12V DC
Low Beam at Full Lean: 4.2A @ 12V DC
High Beam at Full Lean: 5.5A @ 12V DC

Retrofit Information:
5.75" Round (PAR46)

Standards & Application:

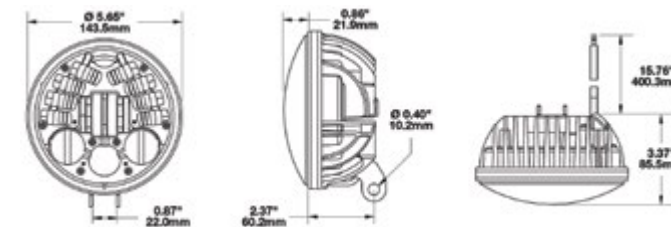
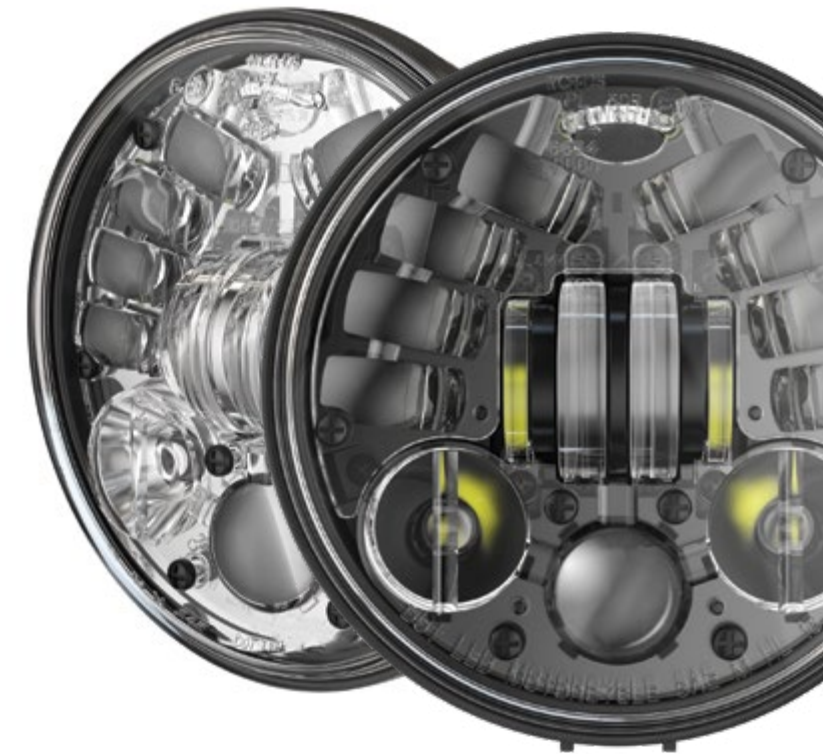

SINGLE PEDESTAL HEADLIGHTS

PART #	BEZEL	DESCRIPTION
0555111	Black	12V DOT/ECE High & Low Beam
0555121	Chrome	12V DOT/ECE High & Low Beam

For fitment information visit: www.jwspeaker.com/garage

If your bike is operated in the United States you do NOT need to connect the Front Position wire (red) unless your bike is equipped with a front position light.

⚠ WARNING: Cancer and Reproductive Harm - www.P65Warnings.ca.gov
⚠ AVERTISSEMENT: Cancer et effet nocif sur la reproduction - www.P65Warnings.ca.gov

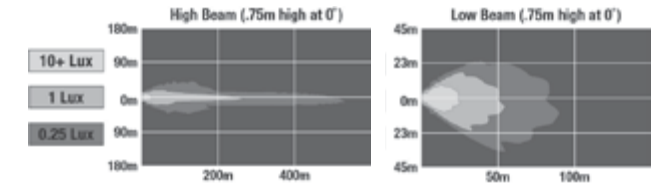



Product Specifications

Raw Lumen Output:
7,020 (High Beam); 4,240 (Low Beam)

Effective Lumen Output:
3,200 (High Beam); 2,040 (Low Beam)

Connector/Wiring:
H4

Operating Voltage:
9-16V DC

Current Draw:
Low Beam: 3.8A @ 12V DC
High Beam: 6.4A @ 12V DC
Front Position: 0.42A @ 12V DC
Low Beam at Full Lean: 8.4A @ 12V DC
High Beam at Full Lean: 11.0A @ 12V DC

Retrofit Information:
Fits 2013 and older Road Glide models

Standards & Application:

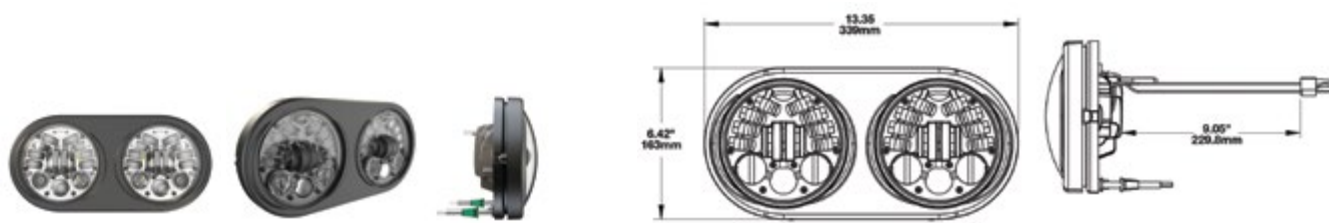

Product Specifications

Raw Lumen Output:
3,520 (High Beam); 2,120 (Low Beam)

Effective Lumen Output:
1,600 (High Beam); 1,050 (Low Beam)

Candela Output:
60,000 (High Beam); 8,300 (Low Beam)

Connector/Wiring:
Integral Connectors

Operating Voltage:
9-16V DC

Current Draw:
Low Beam: 1.9A @ 12V DC
High Beam: 3.2A @ 12V DC
Low Beam at Full Lean: 4.5A @ 12V DC
High Beam at Full Lean: 5.5A @ 12V DC

Retrofit Information:
Victory® Diamond Headlights

Standards & Application:



SINGLE HEADLIGHTS

PART #	BEZEL	DESCRIPTION
0555131	Black	12V DOT/ECE High & Low Beam
0555141	Chrome	12V DOT/ECE High & Low Beam

For more fitment information visit: www.jwspeaker.com/garage

If your bike is operated in the United States you do NOT need to connect the Front Position wire (red) unless your bike is equipped with a front position light.

⚠ WARNING: Cancer and Reproductive Harm - www.P65Warnings.ca.gov
⚠ AVERTISSEMENT: Cancer et effet nocif sur la reproduction - www.P65Warnings.ca.gov

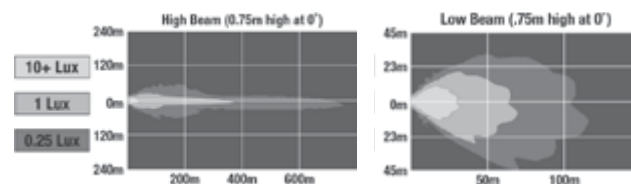

SINGLE HEADLIGHTS

PART #	BEZEL	DESCRIPTION
0555151	Black	12V DOT LED High & Low Beam
0555161	Chrome	12V DOT LED High & Low Beam

For fitment information visit: www.jwspeaker.com/garage

⚠ WARNING: Cancer and Reproductive Harm - www.P65Warnings.ca.gov
⚠ AVERTISSEMENT: Cancer et effet nocif sur la reproduction - www.P65Warnings.ca.gov

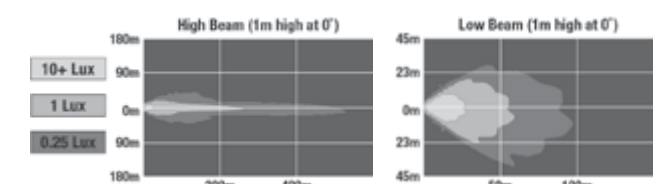



Product Specifications

Raw Lumen Output:
2,250 (High Beam), 2,025 (Low Beam)

Effective Lumen Output:
1,150 (High Beam), 850 (Low Beam)

Candela Output:
48,000 (High Beam), 11,150 (Low Beam)

Connector/Wiring:
H4

Operating Voltage:
9-16V DC

Current Draw:
High Beam: 2.9A @ 13.5V DC
Low Beam: 1.9A @ 13.5V DC
Front Position: 0.092A @ 13.5V DC
Low Beam at Full Lean: 3.5A @ 13.5V DC
High Beam at Full Lean: 4.5A @ 13.5V DC

Retrofit Information:
7" Round (PAR56)

Standards & Application:



SINGLE HEADLIGHTS

PART #	BEZEL	DESCRIPTION
0555011	Black	12V DOT/ECE High & Low Beam
0555031	Chrome	12V DOT/ECE High & Low Beam
0555051	Black	12V DOT/ECE High & Low Beam w/ Mounting Ring
0555061	Chrome	12V DOT/ECE High & Low Beam w/ Mounting Ring

For fitment information visit: www.jwspeaker.com/garage

If your bike is operated in the United States you do NOT need to connect the Front Position wire (red) unless your bike is equipped with a front position light.

PART # ACCESSORIES

8200411	Wire Harness H4 for 7" Round (PAR56) Headlights
3156351	Mounting Ring Kit for 7" Round (PAR56) Headlights

▲ **WARNING:** Cancer and Reproductive Harm - www.P65Warnings.ca.gov
▲ **AVERTISSEMENT:** Cancer et effet nocif sur la reproduction - www.P65Warnings.ca.gov

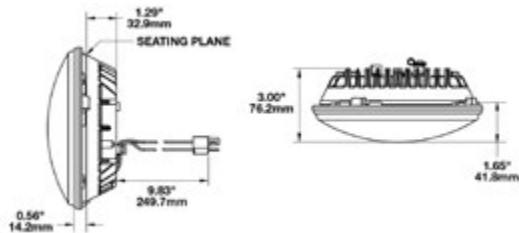
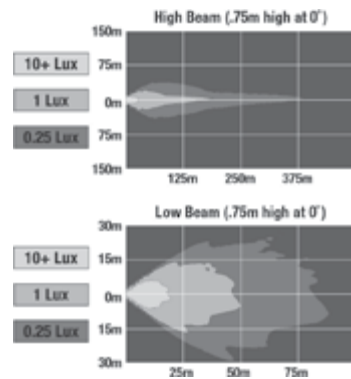

Product Specifications

Raw Lumen Output:
2,250 (High Beam), 2,025 (Low Beam)

Effective Lumen Output:
1,150 (High Beam); 850 (Low Beam)

Candela Output:
48,000 (High Beam); 11,500 (Low Beam)

Connector/Wiring:
Bare Leads

Operating Voltage:
9-16V DC

Current Draw:
High Beam: 4.2A @ 12V DC
Low Beam: 2.0A @ 12V DC
Front Position: 0.092A @ 12V DC
High Beam at Full Lean: 4.5A @ 12V DC
Low Beam at Full Lean: 3.5A @ 12V DC

Retrofit Information:
7" Round (PAR56)

Standards & Application:



SINGLE PEDESTAL HEADLIGHTS

PART #	BEZEL	DESCRIPTION
0555071	Black	12V DOT/ECE High & Low Beam
0555081	Chrome	12V DOT/ECE High & Low Beam

For fitment information visit: www.jwspeaker.com/garage

▲ **WARNING:** Cancer and Reproductive Harm - www.P65Warnings.ca.gov
▲ **AVERTISSEMENT:** Cancer et effet nocif sur la reproduction - www.P65Warnings.ca.gov

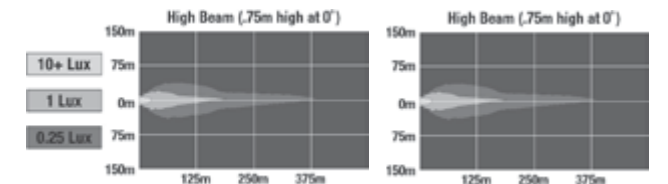

Product Specifications

Raw Lumen Output:
12,250

Effective Lumen Output:
2,850

Candela Output:
Max 240,000

Connector/Wiring:
Deutsch DT06-2S

Operating Voltage:
9-30V DC

Current Draw:
6.7A @ 12V DC (High Beam)
3.8A @ 24V DC (High Beam)

Retrofit Information:
Universal Pedestal Mount

Standards & Application:

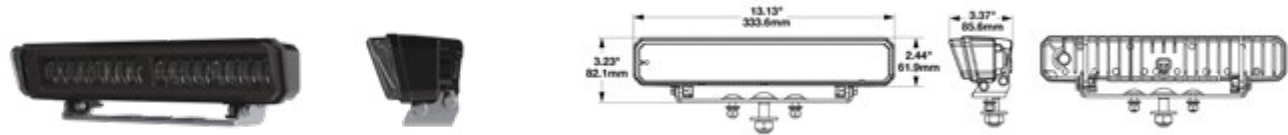

SINGLE LIGHT BAR

PART #	DESCRIPTION
--------	-------------

0561541	12-24V LED Auxiliary Light with Bracket Mount
---------	---

⚠ WARNING: Cancer and Reproductive Harm - www.P65Warnings.ca.gov
⚠ AVERTISSEMENT: Cancer et effet nocif sur la reproduction - www.P65Warnings.ca.gov

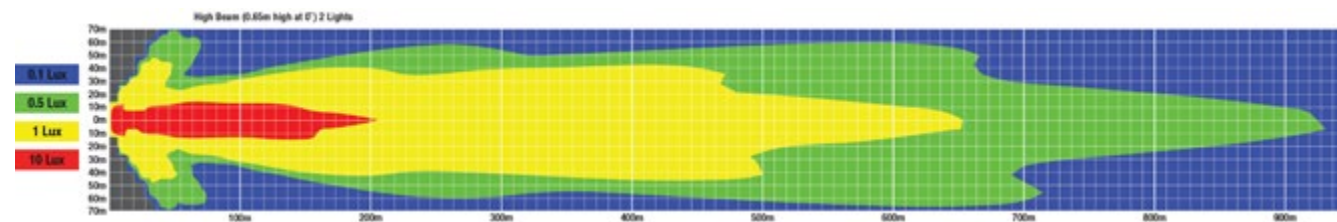

MODEL
9902



ARCH MOTORCYCLE C O M P A N Y

J.W. Speaker will provide its premium LED headlights for all ARCH Motorcycle units built in 2022, including the ARCH KRGT-1 and the upcoming ARCH 1s and ARCH Method 143 models. J.W. Speaker and ARCH Motorcycle will also partner in developing customized LED lighting technology for future ARCH models.

ARCH Motorcycle was founded on the idea of redefining the American performance cruiser and delivers an unrivaled riding and ownership experience through an obsession for innovative design, engineering excellence and dedication to the rider. Every ARCH Motorcycle is delivered via a uniquely collaborative process tailoring livery and ergonomic fit to each owner. What started off as an exploration of what may be possible in the world of motorcycling has quickly evolved into the benchmark for the premium motorcycle category.

FIND THE RIGHT LED HEADLIGHT

No matter what a motorcycle brand sells itself on, it's easy to demonstrate the value of an improvement that enables riders see better at night. Adaptive® 2 headlights have the impact to improve every motorcycle's value, like safety, comfort, quality, style, and ease of use. Regardless of the target price range, manufacturers consider the value of each element in terms of the investment a buyer will make— that is, the value they see in making it uniquely theirs.

J.W. Speaker's Adaptive® 2 headlights are built for motorcycles on the road today. The Adaptive® 2 Series headlights are designed with a plug-and-play fit and easy installation on a variety of motorcycle models – and of course, they look great, too.

Choosing an aftermarket motorcycle headlight can be challenging, that's why we released the J.W. Speaker Motorcycle Garage. With our easy-to-use tool, simply search your bikes make, model, and year. The Garage is complete with headlight brackets and adapter rings for your bike.

We do our best to keep headlight fitment information up-to-date. However, motorcycle manufacturers are frequently updating new bike models, and we can not guarantee that our headlights and fitment kits will fit without minor modifications. Please consult your distributor or dealer for more detailed fitment information.

To find the best light and fitment kit, visit <https://www.jwspeaker.com/garage/>.



Scan to watch our Partnership Video



TRANSPORT

Products featured: Model 8700 Evo 3, 9800 HS, Trail 6 Amber/White, Model 8800 Evo 2, and Model 9600 POD

NEW 5-IN-1 93

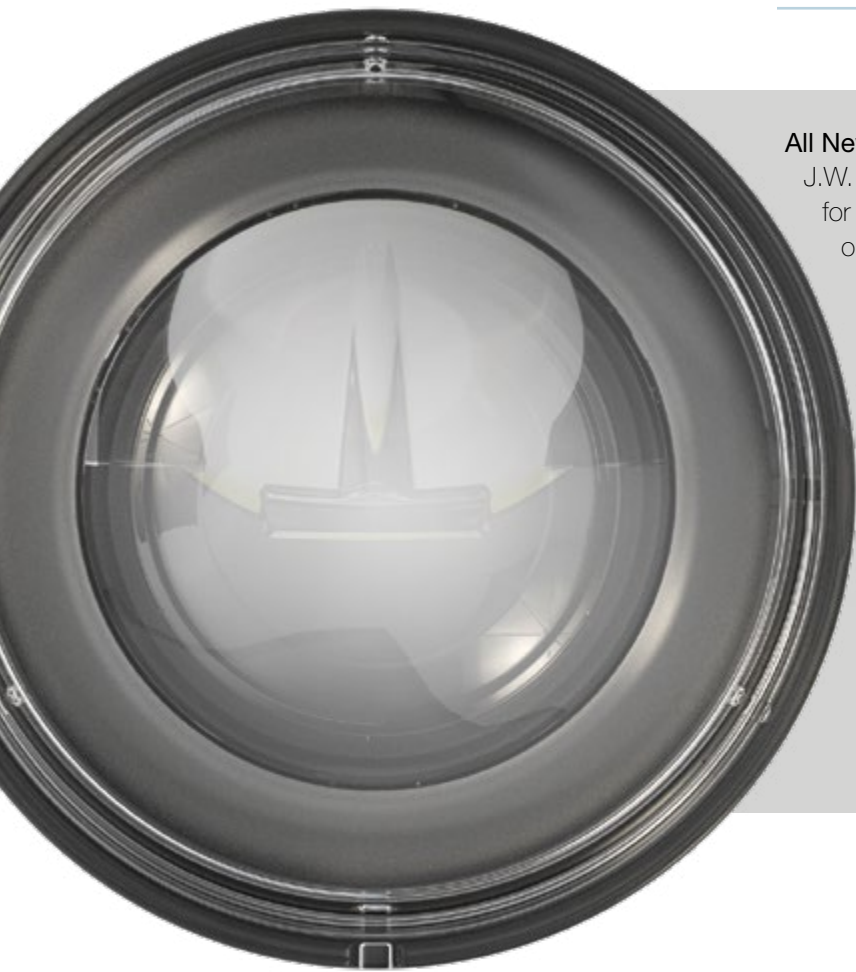

All New 5-in-1 Headlight

J.W. Speaker's LED Model 93 are the new standard for 90mm lights, providing a drop-in replacement or pedestal mounts for original equipment manufacturers (OEMs), up-fitters, vehicle fleets, and individuals looking for the best-performing LED lights. Engineered as a 5-in-1 LED headlight, the Model 93 offers Low Beam, High Beam, Daytime Running Light (DRL), Front Position, and Turn Signal functionality all in one light. The headlight offers many applications for a variety of vehicles suited for agriculture, automotive, construction, industrial, material handling, mining, motorcycle, off-road 4x4, railroad, specialty vehicles, and truck and bus. Our re-designed die cast aluminum housing features a sealed integrated connector to meet the harsh demands of transportation and municipal applications.

PRODUCT SPECIFICATIONS

- Raw Lumen Output:**
1,827 (High Beam); 1,325 (Low Beam)
 - Effective Lumen Output:**
683 (High Beam); 495 (Low Beam)
 - Candela Output:**
44,000 (High Beam); 23,000 (Low Beam)
 - Connector/Wiring:**
Deutsch DT04-2P
 - Operating Voltage:**
9-16V DC
 - Current Draw*:**
High Beam: 1.96A @ 12V DC
Low Beam: 1.35A @ 12V DC
Front Position: 0.111A @ 12V DC
DRL: 1.33A @ 12V DC
- * For the full listing of Current Draws, please visit the respective Product Number's Specification Sheet on our website at www.jwspeaker.com

Retrofit Information:
Standard 90mm lamps

Standards & Application:



SINGLE HEADLIGHTS

BEAM PATTERNS

3-POINT MOUNT

PART #	DESCRIPTION	LOW BEAM	HIGH BEAM	DRL	FP	DI	1.5mm	3mm
0560371	12-24V DOT/ECE R112 RHT 5-in-1 Headlight	X	X	X	X	X		X
0560381	12-24V ECE R112 LHT 5-in-1 Headlight	X	X	X	X	X		X
0560501	12-24V ECE R113 5-in-1 Headlight	X	X	X	X	X		X
0554381	12-24V DOT/ECE High Beam Headlight with FP		X		X		X	X
0553071	12-24V DOT/ECE High Beam Headlight		X				X	X
0553091	12-24V ECE R112 LHT Low Beam Headlight	X					X	X
0553101	12-24V DOT/ECE R112 RHT Low Beam Headlight	X					X	X
0553081	12-24V DOT/ECE R113 Agriculture Low Beam Headlight	X					X	X
0556701	12-24V SAE/ECE Fog Light						X	X
0347941	12-24V SAE/ECE Turn Signal & DRL			X		X	X	X

For parts offered in bulk quantities, please visit the J.W. Speaker website.

MOUNTING OPTIONS

PART #	DESCRIPTION	APPLICATION
8001461	3-point Mount for 1.5mm Mounting Frame	See Above
8001471	3-point Mount for 3mm Mounting Frame	See Above
8201021	3-Point Lock Mount for 3mm Mounting Frame	See Above
8001621	Double Lamp Pedestal Mount Bracket	Any Light
8001601	Single Pedestal Mount Bracket	Any Light

WARNING: Cancer and Reproductive Harm - www.P65Warnings.ca.gov
AVERTISSEMENT: Cancer et effet nocif sur la reproduction - www.P65Warnings.ca.gov

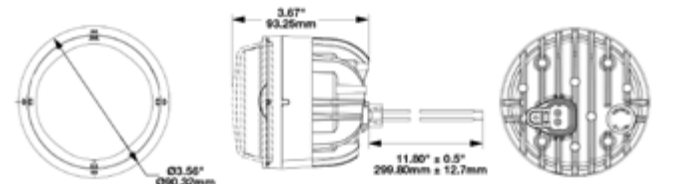
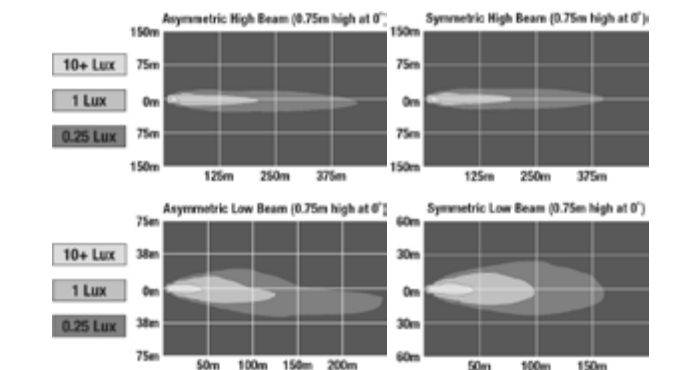

These Model 93 part numbers and specifications are specific to the Transport market. To view other parts under this model, please see the Powersport and Industrial market sections.



Product Specifications

Raw Lumen Output:
630 (High Beam); 1,435 (Fog Beam)

Effective Lumen Output:
230 (High Beam); 607 (Fog Beam)

Candela Output:
45,000 (High Beam); 7,500 (Fog Beam)

Connector/Wiring:
Packard #12162000

Operating Voltage:
10-30V DC

Current Draw:
High Beam: 0.80A @ 12V DC; 0.40A @ 24V DC
Fog Beam: 1.25A @ 12V DC; 0.70A @ 24V DC

Retrofit Information:
2013-2015 Peterbilt 579
2011-2015 Peterbilt 587
2008-2015 Kenworth T660

Standards & Application:

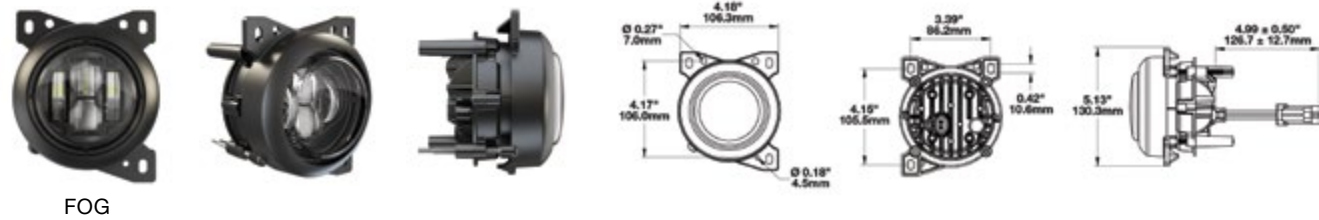

Product Specifications

Raw Lumen Output:
1,800 (High Beam); 1,600 (Low Beam)

Effective Lumen Output:
497 (High Beam); 321 (Low Beam)

Candela Output:
41,800 (High Beam); 14,600 (Low Beam)

Connector/Wiring:
Deutsch DT04-4P

Operating Voltage:
10-32V DC

Current Draw:
High Beam: 1.8A @ 12V DC; 1.0A @ 24V DC
Low Beam: 1.5A @ 12V DC; 0.8A @ 24V DC
Front Position: 0.1A @ 12V DC; 0.06A @ 24V DC

Retrofit Information:
100mm Bi-LED Headlamp

Standards & Application:

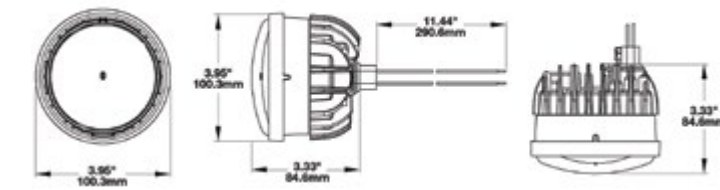

KIT OF 2 FOG LIGHT & HEADLIGHTS

PART #	DESCRIPTION
0553713	12-24V DOT/ECE High Beam Headlight - Kit of 2
0553733	12-24V SAE/ECE RHT & LHT Fog Light - Kit of 2

SINGLE FOG & HEADLIGHT

PART #	DESCRIPTION
0553721	12-24V DOT/ECE High Beam Headlight
0553741	12-24V SAE/ECE RHT & LHT Fog Light

▲ **WARNING:** Cancer and Reproductive Harm - www.P65Warnings.ca.gov
▲ **AVERTISSEMENT:** Cancer et effet nocif sur la reproduction - www.P65Warnings.ca.gov

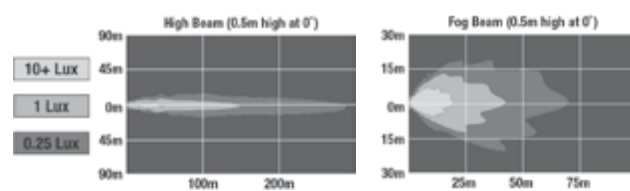

SINGLE HEADLIGHTS

PART #	DESCRIPTION
0554911	12-24V ECE LHT High & Low Beam Headlight (Reg 112)
0554921	12-24V DOT/ECE High & Low Beam Headlight (Reg 113)

PART # MOUNTING OPTIONS

8001511	3-Point Mount for 3mm Mounting Frame
8001521	Single Light Pedestal Mount Bracket

▲ **WARNING:** Cancer and Reproductive Harm - www.P65Warnings.ca.gov
▲ **AVERTISSEMENT:** Cancer et effet nocif sur la reproduction - www.P65Warnings.ca.gov

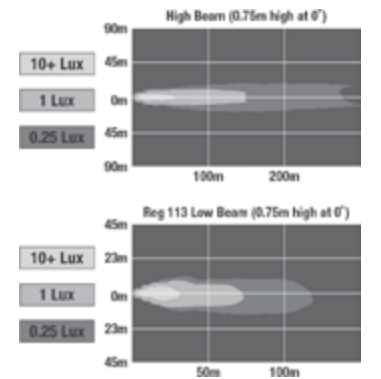

791 FOG LIGHTS



Product Specifications

Raw Lumen Output:
1,820 (Driving/Flood); 800 (Fog)

Effective Lumen Output:
1,200 (Driving/Flood); 250 (Fog)

Candela Output:
6,700 (Fog)

Connector/Wiring:
Driving/Flood: Deutsch DT04-2P
Fog: Integrated 2-Pin Deutsch Connector

Operating Voltage:
Driving/Flood: 9-32V DC
Fog: 10-18V DC

Current Draw:
Driving/Flood: 1.27A @ 12V DC; 0.78A @ 24V DC
Fog: 0.55A @ 10V DC; 0.88A @ 12V DC;
1.10A @ 18V DC

Retrofit Information:
6" x 2" Rectangle

Standards & Application:

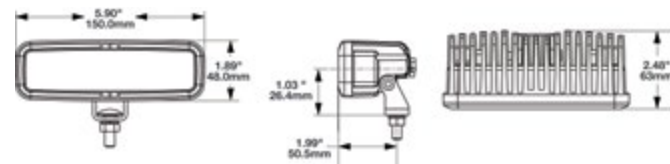

KIT OF 2 FOG LIGHTS

PART #	DESCRIPTION
1603603	12V DOT/ECE LED Fog Light - Kit of 2

SINGLE LIGHTS

PART #	DESCRIPTION
1603601	12V DOT/ECE LED Fog Light
1603511	12-24V LED Driving Light
1603521	12-24V LED Driving Light with Flood Beam Pattern

⚠ **WARNING:** Cancer and Reproductive Harm - www.P65Warnings.ca.gov
 ⚠ **AVERTISSEMENT:** Cancer et effet nocif sur la reproduction - www.P65Warnings.ca.gov

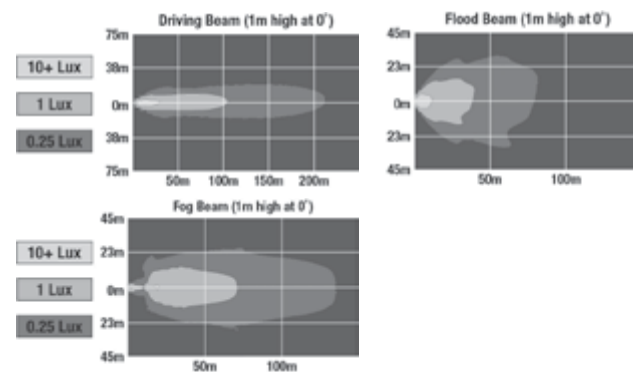

6045 FOG LIGHT



Product Specifications

Raw Lumen Output:
750

Effective Lumen Output:
500

Connector/Wiring:
Packard (#12059450-B)

Operating Voltage:
9-18V DC

Current Draw:
0.75A @ 12V DC

Retrofit Information:
4.5" Round (PAR36)

Standards & Application:

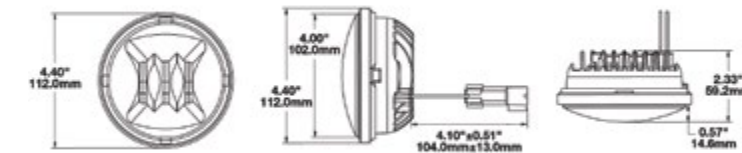

KIT OF 2 FOG LIGHTS

PART #	BEZEL	DESCRIPTION
0551593	Chrome	12V SAE/ECE Fog Light - Kit of 2
0551583	Black	12V SAE/ECE Fog Light - Kit of 2

SINGLE FOG LIGHTS

PART #	BEZEL	DESCRIPTION
0546161	Chrome	12V SAE/ECE RHT Fog Light
0545731	Black	12V SAE/ECE RHT Fog Light
0551653	Chrome	12V SAE/ECE RHT Fog Light w/ Mounting Kit

PART #	ACCESSORIES
8200181	Chrome Mounting Adapter Kit

⚠ **WARNING:** Cancer and Reproductive Harm - www.P65Warnings.ca.gov
 ⚠ **AVERTISSEMENT:** Cancer et effet nocif sur la reproduction - www.P65Warnings.ca.gov

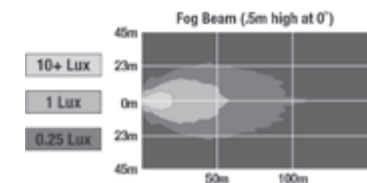



FOG

Product Specifications

Raw Lumen Output:
1,280 (Spot/Driving Beam); 800 (Fog Beam)

Effective Lumen Output:
520 (Spot Beam); 430 (Driving Beam);
250 (Fog Beam)

Candela Output:
8,600 (Spot Beam); 3,000 (Driving Beam)

Connector/Wiring:
Bare Leads

Operating Voltage:
Driving Beam & Spot Beam: 9-32V DC
Fog Beam: 9-18V DC

Current Draw:
1.2A @ 12V DC; 0.6A @ 24V DC

Retrofit Information:
2" x 5" Rectangle

Standards & Application:



DRIVING



SINGLE HEADLIGHTS

PART #	DESCRIPTION
0543591	12-24V LED Auxiliary Light w/ Driving Beam Pattern
0548631	12-24V LED Auxiliary Light w/ Spot Beam Pattern
0549691	12V SAE/ECE LED Auxiliary Light w/ Fog Beam Pattern
0647101	12-24V LED Color Auxiliary Light (Red/Blue/Amber/Green)

WARNING: Cancer and Reproductive Harm - www.P65Warnings.ca.gov
AVERTISSEMENT: Cancer et effet nocif sur la reproduction - www.P65Warnings.ca.gov

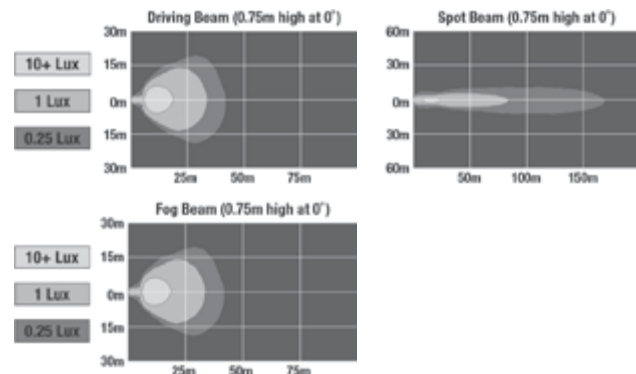

Product Specifications

Raw Lumen Output:
2,925 (High Beam); 2,025 (Low Beam)

Effective Lumen Output:
1,000 (High Beam); 630 (Low Beam)

Candela Output:
61,684 (High Beam); 19,162 (Low Beam)

Connector/Wiring:
Integral Connector in Housing simulating Delphi #12124107

Operating Voltage:
10-32V DC

Current Draw:
Low Beam: 2.20A @12V DC; 1.70A @14V DC; 1.10A @24V DC
High Beam: 3.50A @12V DC; 2.70A @14V DC; 1.70A @24V DC
Turn: 1.40A @12V DC; 0.70A @24V DC
FP: 0.09A @12V DC; 0.07A @14V DC; 0.04A @24V DC
DRL: 0.90A @12V DC; 0.68A @14V DC; 0.38A @24V DC

Retrofit Information:
5.75" Round (PAR46)

Standards & Application:

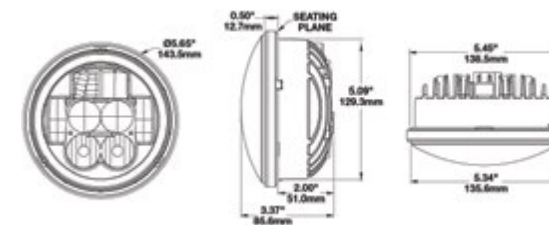

WITH DRL



DOT, NO DRL

SINGLE HEADLIGHTS

PART #	DESCRIPTION
0549911	12-24V DOT/ECE RHT High & Low Beam w/ FP & DRL
0549921	12-24V ECE LHT High & Low Beam w/ FP & DRL
0550921	12-24V DOT High & Low Beam

If your vehicle is operated in the United States you do NOT need to connect the Front Position wire (red) unless your vehicle is equipped with a front position light.

PART # ACCESSORIES

3157751	Double Ring Kit Mounting Assembly
8200001	Single Light Mounting Assembly

WARNING: Cancer and Reproductive Harm - www.P65Warnings.ca.gov
AVERTISSEMENT: Cancer et effet nocif sur la reproduction - www.P65Warnings.ca.gov

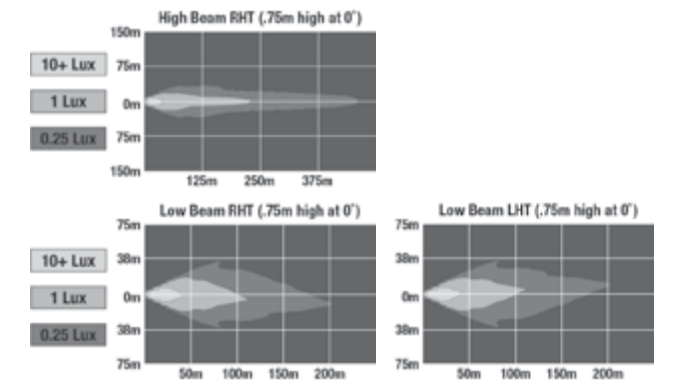

8631 EVOLUTION



Product Specifications

Raw Lumen Output:
2,925 (High Beam); 2,025 (Low Beam)

Effective Lumen Output:
1,000 (High Beam); 630 (Low Beam)

Candela Output:
61,684 (High Beam); 19,162 (Low Beam)

Connector/Wiring:
Delphi #12124107

Operating Voltage:
10-32V DC

Current Draw*:
Low Beam: 2.20A @12V DC; 1.70A @14V DC; 1.10A @24V DC
High Beam: 3.50A @12V DC; 2.70A @14V DC; 1.70A @24V DC
DRL: 1.10A @12V DC; 0.70A @24V DC

* For the full listing of Current Draws, please visit the respective Product Number's Specification Sheet on our website at www.jwspeaker.com

Retrofit Information:
5.75" Round (PAR46)

Standards & Application:

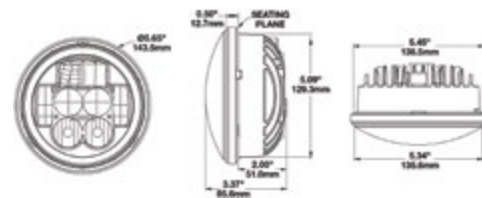

8632 EVOLUTION



Product Specifications

Raw Lumen Output:
2,925 (High Beam); 2,025 (Low Beam)

Effective Lumen Output:
1,000 (High Beam); 630 (Low Beam)

Connector/Wiring:
Integral Connector in housing simulating Delphi 12124107

Operating Voltage:
10-32V DC

Current Draw*:
High Beam: 3.67A @ 12V DC; 1.83A @ 24V DC
Low Beam: 2.5A @ 12V DC; 1.25A @ 24V DC
DRL: 0.067A @ 12V DC; 0.34A @ 24V DC
Front Turn: 0.83A @ 12V DC; 0.42A @ 24V DC
Front Position: 0.08A @ 12V DC; 0.042A @ 24V DC
Side Marker: 0.08A @ 12V DC; 0.042A @ 24V DC

* For the full listing of Current Draws, please visit the respective Product Number's Specification Sheet on our website at www.jwspeaker.com

Retrofit Information:
5.75" Round (PAR46) Pedestal Lights

Standards & Application:



SINGLE HEADLIGHTS

PART #	DESCRIPTION
0551641	12-24V ECE LHT High & Low Beam w/ Turn, FP & DRL
0551631	12-24V DOT/ECE RHT High & Low Beam w/ Turn, FP & DRL

If your vehicle is operated in the United States you do NOT need to connect the Front Position wire (red) unless your vehicle is equipped with a front position light.

PART #	ACCESSORIES
3157751	Double Light Mounting Ring Kit
8200001	Single Light Mounting Ring Kit
8200071	Mounting Ring Kit for 5.75" Round (PAR46) Headlights

WARNING: Cancer and Reproductive Harm - www.P65Warnings.ca.gov
AVERTISSEMENT: Cancer et effet nocif sur la reproduction - www.P65Warnings.ca.gov

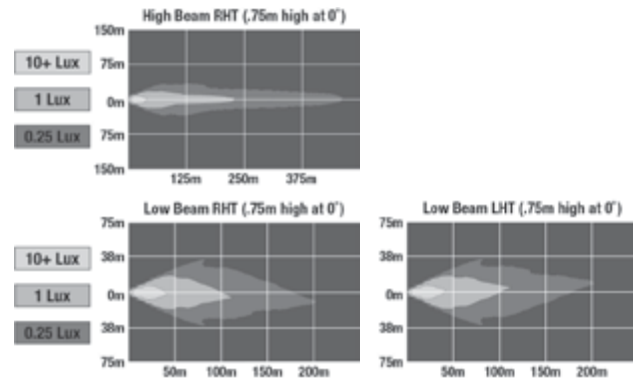

KIT OF 2 PEDESTAL HEADLIGHTS

PART #	DESCRIPTION
0551983	12-24V DOT/ECE RHT High & Low Beam w/ Turn, FP & DRL - Kit of 2
0551973	12-24V ECE LHT High & Low Beam w/ Turn, FP & DRL - Kit of 2

HEATED SINGLE PEDESTAL HEADLIGHTS

PART #	DESCRIPTION
0530031	24V ECE LED RHT Heated High & Low Beam Headlight with Turn Signal & FP
0530041	24V ECE LED LHT Heated High & Low Beam Headlight with Turn Signal & FP

SINGLE PEDESTAL HEADLIGHTS

PART #	DESCRIPTION
0551561	12-24V DOT/ECE RHT High & Low Beam w/ Turn, FP & DRL - RH Light
0551571	12-24V DOT/ECE RHT High & Low Beam w/ Turn, FP & DRL - LH Light
0551991	12-24V ECE LHT High & Low Beam w/ Turn, FP & DRL - RH Light
0552001	12-24V ECE LHT High & Low Beam w/ Turn, FP & DRL - LH Light

*RH & LH refer to right hand and left hand lights on the vehicle.

If your vehicle is operated in the United States you do NOT need to connect the Front Position wire (red) unless your vehicle is equipped with a front position light.

WARNING: Cancer and Reproductive Harm - www.P65Warnings.ca.gov
AVERTISSEMENT: Cancer et effet nocif sur la reproduction - www.P65Warnings.ca.gov

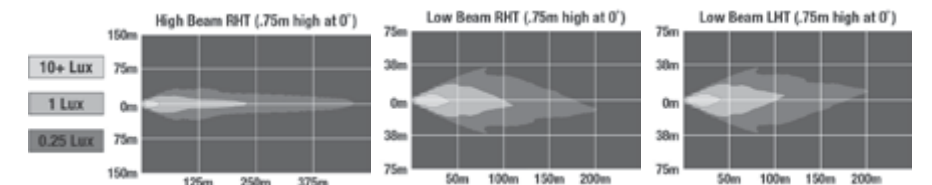

8633 EVOLUTION



Product Specifications

Raw Lumen Output:
2,925 (High Beam); 2,025 (Low Beam)

Effective Lumen Output:
1,000 (High Beam); 660 (Low Beam)

Candela Output:
51,000 (High Beam); 23,000 (Low Beam)

Connector/Wiring:
Delphi #12124107

Input Voltage:
12-24V DC

Current Draw*:
Low Beam: 3.50A @13.5V DC; 1.80A @28V DC
High Beam: 4.00A @13.5 DC; 2.0A @28V DC
DRL: 2.80A @13.5V DC; 1.40A @28V DC
Front Turn: 0.80A @13.5V DC; 0.40A @28V DC
Front Position: 2.40A @13.5V DC; 1.20A @28V DC

* For the full listing of Current Draws, please visit the respective Product Number's Specification Sheet on our website at www.jw-speaker.com

Retrofit Information:
5.75" Round (PAR46)

Standards & Application:

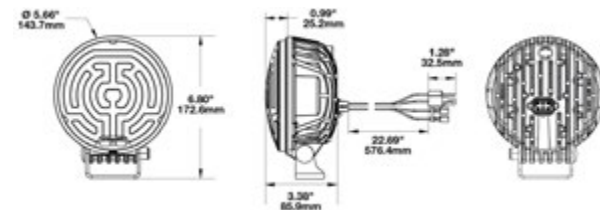

HEATED KIT OF 2 PEDESTAL HEADLIGHTS

PART #	DESCRIPTION
0561303	12-24V DOT/ECE RHT High & Low Beam w/ Turn, FP & DRL - Kit of 2
0561313	12-24V ECE LHT High & Low Beam w/ Turn, FP & DRL - Kit of 2

HEATED SINGLE PEDESTAL HEADLIGHTS

PART #	DESCRIPTION
0561301	12-24V DOT/ECE RHT High & Low Beam w/ Turn, FP & DRL
0561311	12-24V ECE LHT High & Low Beam w/ Turn, FP & DRL

If your vehicle is operated in the United States you do NOT need to connect the Front Position wire (red) unless your vehicle is equipped with a front position light.

PART #	ACCESSORIES
3268991	5 Function Wire Assembly

WARNING: Cancer and Reproductive Harm - www.P65Warnings.ca.gov
AVERTISSEMENT: Cancer et effet nocif sur la reproduction - www.P65Warnings.ca.gov

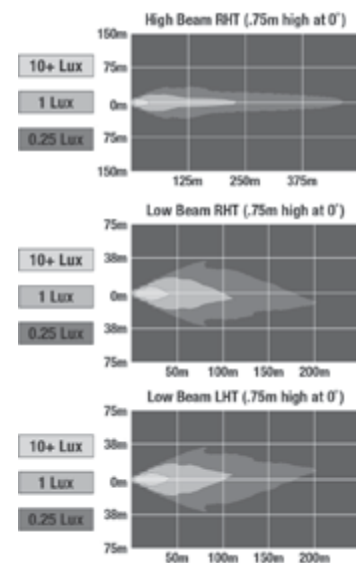



Product Specifications

Raw Lumen Output:
3,200 (High Beam); 1,770 (Low Beam)

Effective Lumen Output:
1,260 (High Beam); 750 (Low Beam)

Candela Output:
71,500 (High Beam); 35,003 (Low Beam)

Connector/Wiring:
H4

Operating Voltage:
9-32V DC

Current Draw*:
High Beam: 3.50A @ 12V DC; 1.80A @ 24V DC
Low Beam: 2.00A @ 12V DC; 1.10A @ 24V DC

* For the full listing of Current Draws, please visit the respective Product Number's Specification Sheet on our website at www.jwspeaker.com

Retrofit Information:
7" Round (PAR56)

Standards & Application:

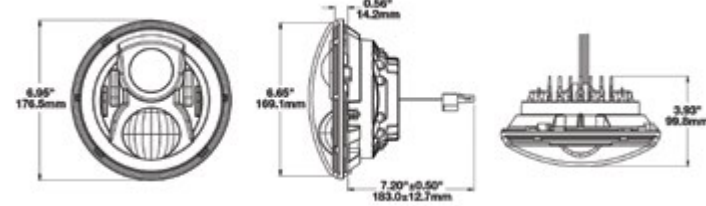

Product Specifications

Raw Lumen Output:
4,170 (High Beam); 2,340 (Low Beam)

Effective Lumen Output:
1,340 (High Beam); 694 (Low Beam)

Candela Output:
84,700 (High Beam); 30,600 (Low Beam)

Connector/Wiring:
H4

Operating Voltage:
9-32V DC

Current Draw:
High Beam: 3.60A @ 12V DC; 1.80A @ 24V DC
Low Beam: 2.00A @ 12V DC; 1.10A @ 24V DC
Front Position: 0.16A @ 12V DC; 0.10A @ 24V DC
DRL: 1.60A @ 12V DC; 0.80A @ 24V DC

Retrofit Information:
7" Round (PAR56)

Standards & Application:

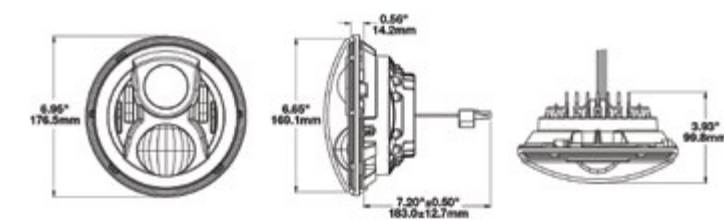

HEATED SINGLE HEADLIGHTS

PART #	BEZEL	DESCRIPTION
0556281	Black	12-24V DOT Heated High & Low Beam
0556291	Chrome	12-24V DOT Heated High & Low Beam
0556301	Black	12-24V ECE Heated RHT High & Low Beam w/ DRL & FP
0556311	Chrome	12-24V ECE Heated RHT High & Low Beam w/ DRL & FP
0556321	Black	12-24V ECE Heated LHT High & Low Beam w/ DRL & FP
0556331	Chrome	12-24V ECE Heated LHT High & Low Beam w/ DRL & FP

PART # ACCESSORIES

3156351	Mounting Ring Kit for 7" Round (PAR56) Headlights
3266081	Jumper Harness H4/H13
8000381	Anti-Flicker Harness H4/H4
8000311	Anti-Flicker Harness H4/H13

⚠ WARNING: Cancer and Reproductive Harm - www.P65Warnings.ca.gov
⚠ AVERTISSEMENT: Cancer et effet nocif sur la reproduction - www.P65Warnings.ca.gov

NON-HEATED SINGLE HEADLIGHTS

PART #	BEZEL	DESCRIPTION
0554941	Black	12-24V DOT High & Low Beam
0554961	Chrome	12-24V DOT High & Low Beam
0554981	Black	12-24V DOT High & Low Beam w/ Mounting Ring
0554991	Chrome	12-24V DOT High & Low Beam w/ Mounting Ring

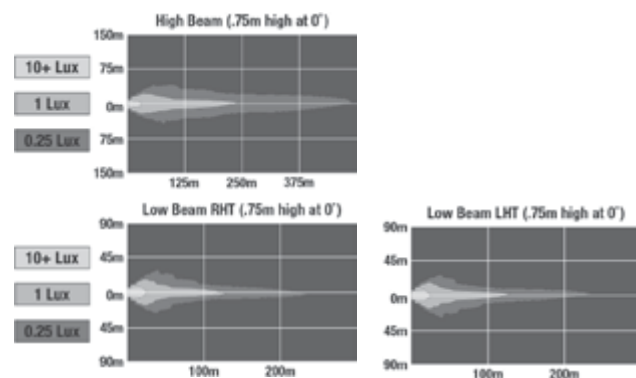

SINGLE HEADLIGHTS

PART #	BEZEL	DESCRIPTION
0556981	Black	12-24V ECE RHT High & Low Beam w/ DRL & FP
0556971	Chrome	12-24V ECE RHT High & Low Beam w/ DRL & FP
0556961	Black	12-24V ECE LHT High & Low Beam w/ DRL & FP
0556951	Chrome	12-24V ECE LHT High & Low Beam w/ DRL & FP
0557501	Black	12-24V ECE LHT High & Low Beam
0557511	Black	12-24V ECE RHT High & Low Beam

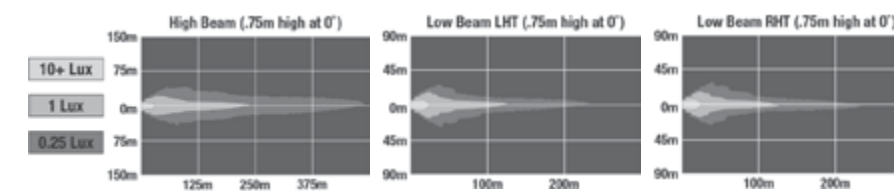

PART # ACCESSORIES

3156351	Mounting Ring Kit for 7" Round (PAR56) Headlights
3266081	Jumper Harness H4/H13
8000381	Anti-Flicker Harness H4/H4
8000311	Anti-Flicker Harness H4/H13

⚠ WARNING: Cancer and Reproductive Harm - www.P65Warnings.ca.gov
⚠ AVERTISSEMENT: Cancer et effet nocif sur la reproduction - www.P65Warnings.ca.gov

NEW 8700 EVO 3



Putting the "Power" in Powerhouse.

The 8700 EVO 3 is a 5-in-1 headlight that has state-of-the-art optics and technology that provides a crisp beam with a wider, more even pattern.

5-in-1 Headlight

Built with five functions packed into one Heavy Duty Truck LED Headlight: High Beam, Low Beam, Turn Signal, Daytime Running Light (DRL), and Front Position. Powerful LEDs & precisely engineered light patterns give you the best visibility for the best driving experience.

Stay safe all year round.

Keep headlights free of snow and ice with the heated lens versions of the 8700 EVO 3. Built-in SmartHeat® technology de-ices lenses for the best safety and visibility in any condition.



PRODUCT SPECIFICATIONS

Raw Lumen Output:
3,600 (High Beam); 3,020 (Low Beam)

Effective Lumen Output:
1,320 (High Beam); 1,201 (Low Beam)

Candela Output:
68,800 (High Beam); 24,800 (Low Beam)

Connector/Wiring:
H4 / (3X) 11.97" Flying Leads

Operating Voltage:
9-16V DC

Current Draw*:
Low Beam: 2.33A @ 12V DC
High Beam: 3.25A @ 12V DC
Front Turn: 3.00A @ 12V DC
DRL: 3.00A @ 12V DC

* For the full listing of Current Draws, please visit the respective Product Number's Specification Sheet on our website at www.jwspeaker.com

Retrofit Information:
7" Round Headlights or 2D1 PAR56

Standards & Application:

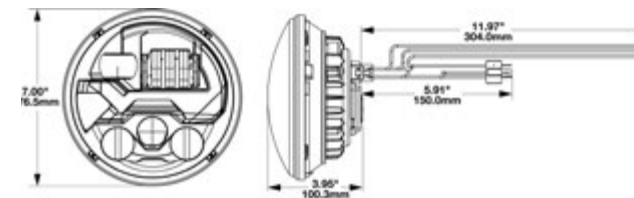

HEATED KIT OF 2 HEADLIGHTS

PART #	BEZEL	DESCRIPTION
0558253	Chrome	12V LHT ECE High & Low Beam Heated - Kit of 2

HEATED SINGLE HEADLIGHTS

PART #	BEZEL	DESCRIPTION
0558201	Chrome	12V RHT DOT/ECE Heated High & Low Beam - RH
0558211	Chrome	12V RHT DOT/ECE Heated High & Low Beam - LH
0558281	Chrome	12V LHT ECE Heated High & Low Beam - RH
0558291	Chrome	12V LHT ECE Heated High & Low Beam - LH

⚠ **WARNING:** Cancer and Reproductive Harm - www.P65Warnings.ca.gov
⚠ **AVERTISSEMENT:** Cancer et effet nocif sur la reproduction - www.P65Warnings.ca.gov

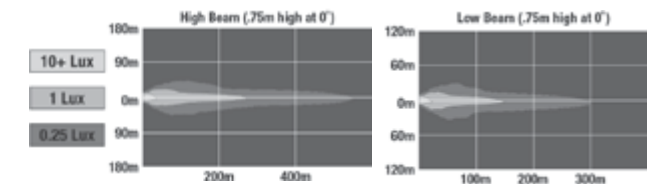

NON-HEATED KIT OF 2 HEADLIGHTS

PART #	BEZEL	DESCRIPTION
0558243	Black	12V LHT ECE High & Low Beam - Kit of 2
0530193	Black	12V LHT ECE High & Low Beam - Kit of 2

NON-HEATED SINGLE HEADLIGHTS

PART #	BEZEL	DESCRIPTION
0558161	Chrome	12V RHT DOT/ECE High & Low Beam - RH
0558171	Chrome	12V RHT DOT/ECE High & Low Beam - LH
0558261	Chrome	12V LHT ECE High & Low Beam - RH
0558271	Chrome	12V LHT ECE High & Low Beam - LH
0530181	Black	12V LHT ECE High & Low Beam - RH
0530171	Black	12V LHT ECE High & Low Beam - LH



Product Specifications

Raw Lumen Output:
3,300

Effective Lumen Output:
1,440

Candela Output:
133,000

Connector/Wiring:
H4

Operating Voltage:
9-32V DC

Current Draw:
4.80A @ 12V DC; 2.50A @ 24V DC

Retrofit Information:
7" Round (PAR56)

Standards & Application:

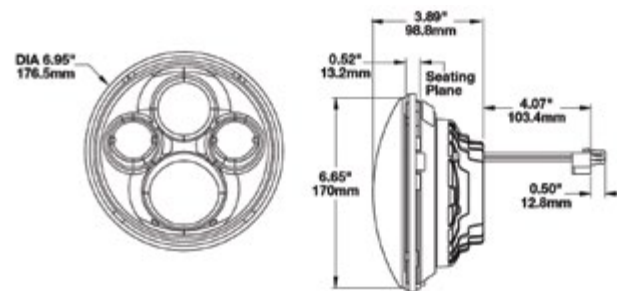

SINGLE HEADLIGHTS

PART #	BEZEL	DESCRIPTION
0550011	Chrome	12-24V ECE LED RHT & LHT High Beam
0550021	Black	12-24V ECE LED RHT & LHT High Beam

PART # ACCESSORIES

3156351	Mounting Ring Kit for 7" Round (PAR56) Headlights
3266081	Jumper Harness H4/H13

⚠ **WARNING:** Cancer and Reproductive Harm - www.P65Warnings.ca.gov
 ⚠ **AVERTISSEMENT:** Cancer et effet nocif sur la reproduction - www.P65Warnings.ca.gov

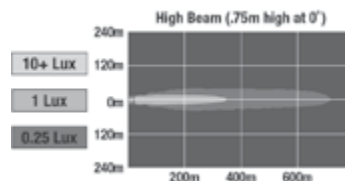

Product Specifications

Raw Lumen Output:
3,547(High Beam); 2,800 (Low Beam)

Effective Lumen Output:
1,400 (High Beam); 925 (Low Beam)

Candela Output:
62,100 (High Beam); 20,500 (Low Beam)

Connector/Wiring:
H4

Operating Voltage:
9-30V DC

Current Draw:
Low Beam: 2.25A @ 12V DC; 1.00A @ 24V DC
High Beam: 2.75A @ 12V DC; 1.25A @ 24V DC

Retrofit Information:
7" Round (PAR56)

Standards & Application:

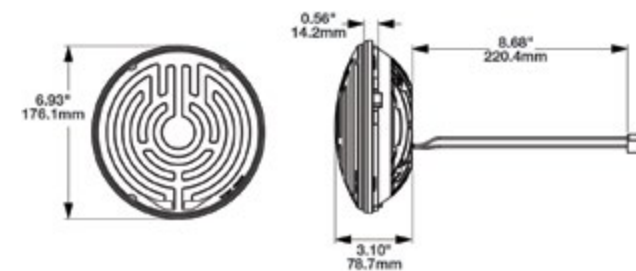
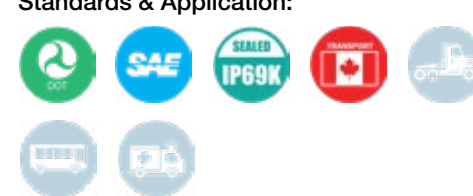

HEATED KIT OF 2 HEADLIGHTS

PART #	BEZEL	DESCRIPTION
0555883	Black	12-24V Heated RH & LH Headlight - Kit of 2
0557463	Chrome	12-24V Heated RH & LH Headlight - Kit of 2

NON-HEATED KIT OF 2 HEADLIGHTS

PART #	BEZEL	DESCRIPTION
0557423	Black	12-24V RH & LH Headlight - Kit of 2
0557493	Chrome	12-24V RH & LH Headlight - Kit of 2

⚠ **WARNING:** Cancer and Reproductive Harm - www.P65Warnings.ca.gov
 ⚠ **AVERTISSEMENT:** Cancer et effet nocif sur la reproduction - www.P65Warnings.ca.gov

PART # ACCESSORIES

8200791	Thomas Built Bus 7inch Headlight Mounting Kit
---------	---

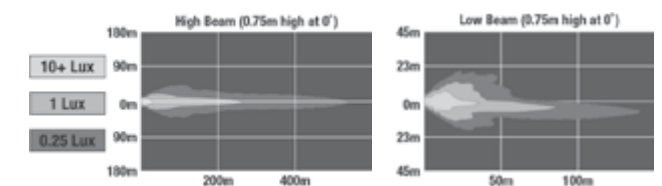



8800 EVOLUTION 2

Product Specifications

Raw Lumen Output:
2,250 (High Beam); 2,830 (Low Beam)

Effective Lumen Output:
898 (High Beam); 782 (Low Beam)

Candela Output:
73,200 (High Beam); 29,800 (Low Beam)

Connector/Wiring:
H4 Connector - AMP (#172615-2)

Operating Voltage:
9-32V DC

Current Draw:
Heated: 3.30A @ 12V DC; 1.67A @ 24V DC
Non-Heated: 2.10A @ 12V DC; 1.00A @ 24V DC

Retrofit Information:
4" x 6" Rectangle; 1A1 and 2A1 Sealed Beams

Standards & Application:



LOW BEAM,
NON-HEATED

HIGH BEAM, HEATED

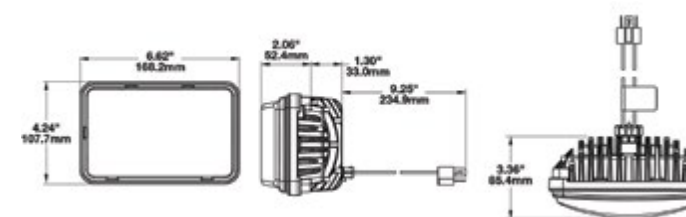

LOW BEAM,
HEATED

HIGH BEAM,
NON-HEATED

HEATED SINGLE HEADLIGHTS

PART #	BEZEL	DESCRIPTION
0551771	Chrome	12-24V DOT/ECE RHT Heated Low Beam
0552651	Black	12-24V DOT/ECE RHT Heated Low Beam
0552091	Chrome	12-24V ECE LHT Heated Low Beam
0552661	Black	12-24V ECE LHT Heated Low Beam
0551781	Chrome	12-24V DOT ECE Heated High Beam
0552671	Black	12-24V DOT ECE Heated High Beam

PART # ACCESSORIES

3269601	Low Beam Harness for 8800 Evolution 2
3269611	High Beam Harness for 8800 Evolution 2
3270821	Harness, Load Equalizer, H4, 16 OHM, 50W
8000381	Anti-Flicker Harness H4/H4

NON-HEATED SINGLE HEADLIGHTS

PART #	BEZEL	DESCRIPTION
0551371	Chrome	12-24V DOT/ECE RHT Low Beam
0552551	Black	12-24V DOT/ECE RHT Low Beam
0551391	Chrome	12-24V ECE LHT Low Beam
0552561	Black	12-24V ECE LHT Low Beam
0551381	Chrome	12-24V DOT ECE High Beam
0552571	Black	12-24V DOT ECE High Beam

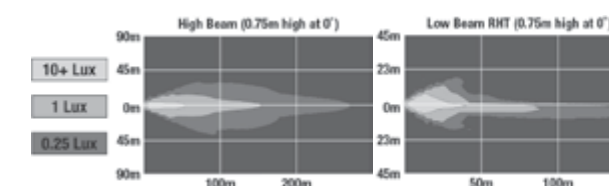

**8800
EVOLUTION 2**

▲ **WARNING:** Cancer and Reproductive Harm - www.P65Warnings.ca.gov
▲ **AVERTISSEMENT:** Cancer et effet nocif sur la reproduction - www.P65Warnings.ca.gov

Find the full specs of our products at www.jwspeaker.com

8900 EVOLUTION 2



8910 EVOLUTION 2



Product Specifications

Raw Lumen Output:
2,640 (High Beam); 2,250 (Low Beam)

Effective Lumen Output:
1,200 (High Beam); 975 (Low Beam)

Connector/Wiring:
H4

Operating Voltage:
10-32V DC

Current Draw:
High Beam: 1.94A @ 12V; 1.03A @ 24V DC
Low Beam: 1.67A @ 12V; 0.87A @ 24V DC
Front Position: 0.22A @ 12V; 0.16A @ 24V DC

Retrofit Information:
5" x 7" Rectangle; 2B1 Sealed Beams

Standards & Application:

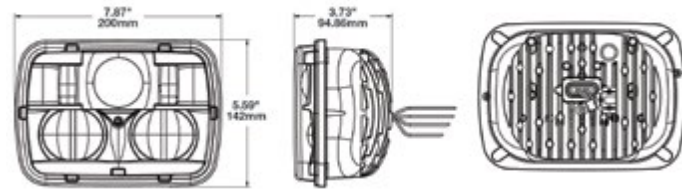

SINGLE HEADLIGHTS

PART #	BEZEL	DESCRIPTION
0554471	Chrome	12-24V DOT/ECE RHT High & Low Beam w/ FP
0554491	Black	12-24V DOT/ECE RHT High & Low Beam w/ FP
0554431	Chrome	12-24V ECE LHT High & Low Beam w/ FP
0554451	Black	12-24V ECE LHT High & Low Beam w/ FP

PART # ACCESSORIES

8000381	H4/H4 Anti-Flicker Harness
---------	----------------------------

If your vehicle is operated in the United States you do NOT need to connect the Front Position wire (red) unless your vehicle is equipped with a front position light.

⚠ WARNING: Cancer and Reproductive Harm - www.P65Warnings.ca.gov
⚠ AVERTISSEMENT: Cancer et effet nocif sur la reproduction - www.P65Warnings.ca.gov

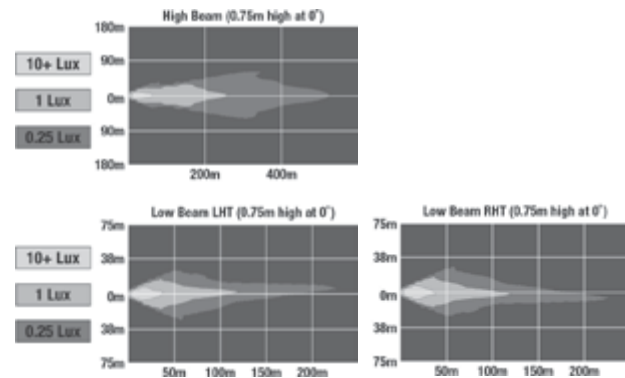

Product Specifications

Raw Lumen Output:
3,015 (High Beam); 2,250 (Low Beam)

Effective Lumen Output:
1,320 (High Beam); 975 (Low Beam)

Connector/Wiring:
H4

Operating Voltage:
10-32V DC

Current Draw:
High Beam: 5.35A @ 12V DC; 2.50A @ 24V DC
Low Beam: 4.30A @ 12V DC; 2.10A @ 24V DC
Front Position: 2.80A @ 12V DC; 1.32A @ 24V DC

Retrofit Information:
5" x 7" Rectangle; 2B1 Sealed Beams

Standards & Application:

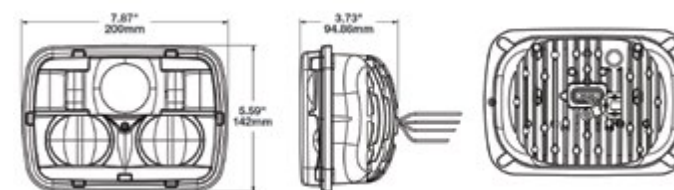

HEATED SINGLE HEADLIGHTS

PART #	BEZEL	DESCRIPTION
0554481	Black	12-24V DOT/ECE RHT Heated High & Low Beam w/ FP
0554461	Chrome	2-24V DOT/ECE RHT Heated High & Low Beam w/ FP
0554441	Black	12-24V ECE LHT Heated High & Low Beam w/ FP
0554421	Chrome	12-24V ECE LHT Heated High & Low Beam w/ FP

PART # ACCESSORIES

8000381	H4/H4 Anti-Flicker Harness
---------	----------------------------

If your vehicle is operated in the United States you do NOT need to connect the Front Position wire (red) unless your vehicle is equipped with a front position light.

⚠ WARNING: Cancer and Reproductive Harm - www.P65Warnings.ca.gov
⚠ AVERTISSEMENT: Cancer et effet nocif sur la reproduction - www.P65Warnings.ca.gov

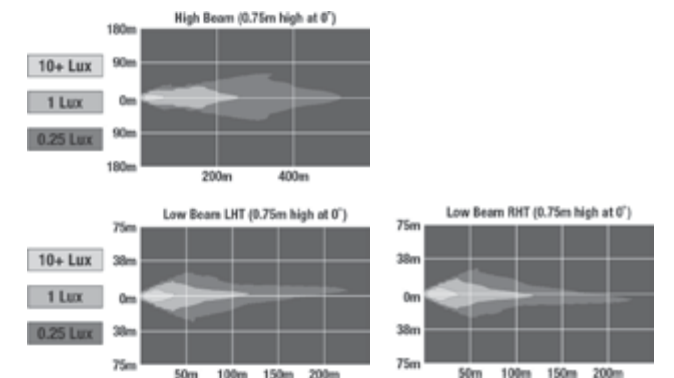

9600 POD



Look Forward. Shine Brighter.

Rediscover the beauty of your Peterbilt truck in a new way. The Model 9600 Peterbilt POD LED Headlight is expertly engineered with outstanding durability, stunning performance, and superior visibility. The iconic plug and play POD light design delivers an innovative style to complement and enhance Peterbilt 388/389 & 567 trucks.

This 5-in-1 headlight uses a unique “blade” design to integrate turn signal performance and front position optics while using Bi-LED technology to digitally switch between high and low beam. Complete with optional SmartHeat® technology, the Model 9600 is designed to automatically remove ice and snow from the lens, giving Peterbilt drivers better visibility in treacherous winter conditions.



PRODUCT SPECIFICATIONS

Raw Lumen Output:

2895 (High Beam); 1200 (Low Beam)

Effective Lumen Output:

1020 (High Beam); 614 (Low Beam)

Connector/Wiring:

Deutsch DT04-8PA

Operating Voltage:

9-18V DC

Current Draw:

High Beam: 4.2A @ 12V DC

Low Beam: 2.1A @ 12V DC

Turn: 2.15A @ 12V DC

Side Marker/Parking: 0.34A @ 12V DC

Retrofit Information:

Peterbilt 388/389 & 567

Standards & Application:



HIGH BEAM

LOW BEAM & TURN



FRONT POSITION

DRL

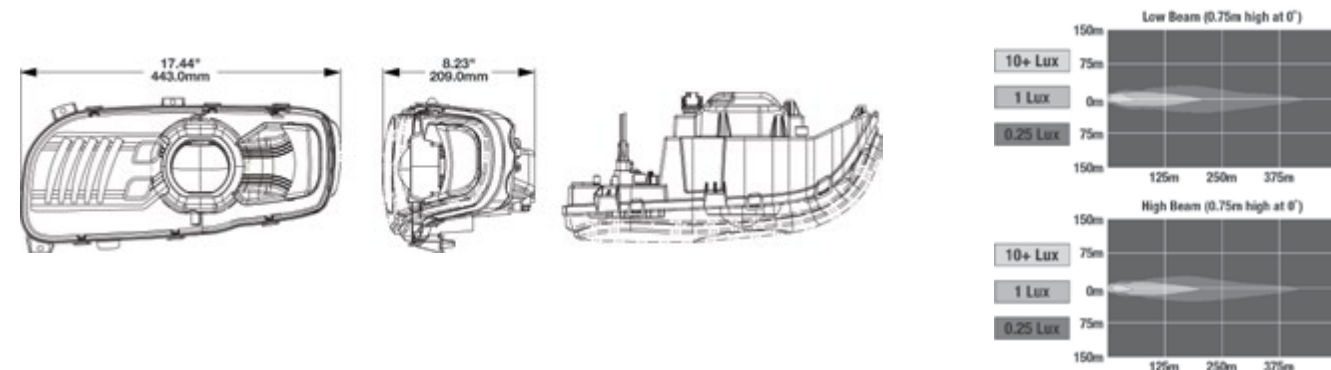

HEATED SINGLE HEADLIGHTS

PART #	DESCRIPTION
0562511	12V Peterbilt LED Heated Headlight, Left-hand, Chrome Bezel
0562521	12V Peterbilt LED Heated Headlight, Right-hand, Chrome Bezel
0562551	12V Peterbilt LED Heated Headlight, Left-hand, Black Bezel
0562561	12V Peterbilt LED Heated Headlight, Right-hand, Black Bezel

WARNING: Cancer and Reproductive Harm - www.P65Warnings.ca.gov
AVERTISSEMENT: Cancer et effet nocif sur la reproduction - www.P65Warnings.ca.gov

NON-HEATED SINGLE HEADLIGHTS

PART #	DESCRIPTION
0562531	12V Peterbilt LED Headlight, Left-hand, Chrome Bezel
0562531	12V Peterbilt LED Headlight, Right-hand, Chrome Bezel
0562571	12V Peterbilt LED Headlight, Left-hand, Black Bezel
0562581	12V Peterbilt LED Headlight, Right-hand, Black Bezel

WIRE HARNESSES (SOLD SEPARATELY)

PART #	ACCESSORIES
3271081	Wire Harness for Peterbilt Trucks 388, 389, & 567, Years 2023 & Older
3272531	Wire Harness for Peterbilt Trucks 567 & 589, Years 2024 & Newer



Find the full specs of our products at www.jwspeaker.com

Product Specifications

Raw Lumen Output:
2,880 (High Beam); 2,160 (Low Beam)

Effective Lumen Output:
1,150 (High Beam); 800 (Low Beam)

Candela Output:
52,000 (High Beam)

Mating Connector:
Delphi (#12052848)

Operating Voltage:
12V: 10-15V
24V: 20-32V DC

Current Draw:
High Beam: 3.40A @ 12V DC; 1.60A @ 24V DC
Low Beam: 2.70A @ 12V DC; 1.20A @ 24V DC
Turn Signal: 0.85A @ 12V DC; 0.27A @ 24V DC
FP & DRL: 0.04A @ 12V DC; 0.03A @ 24V DC

Retrofit Information:
5" x 11" Rectangle; Pedestal Mount Headlights

Standards & Application:

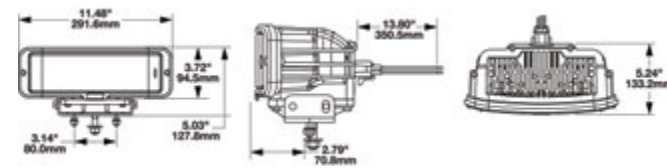

Product Specifications

Raw Lumen Output:
2,880 (High Beam); 2,160 (Low Beam)

Effective Lumen Output:
1,150 (High Beam); 800 (Low Beam)

Candela Output:
52,000 (High Beam)

Mating Connector:
Delphi (#12052848)

Operating Voltage:
12-24V DC

Current Draw:
High Beam: 2.50A @ 12V; 1.50A @ 24V DC
Low Beam: 1.75A @ 12V; 1.00A @ 24V DC
Turn: 0.750A @ 12V DC; .280A @ 24V DC
Front Position: 0.040A @ 12V DC; .025A @ 24V DC
Heater: 2.00A @ 12V DC; 1.75A @ 24V DC

Retrofit Information:
5" x 11" Rectangle; Pedestal Mount Headlights

Standards & Application:

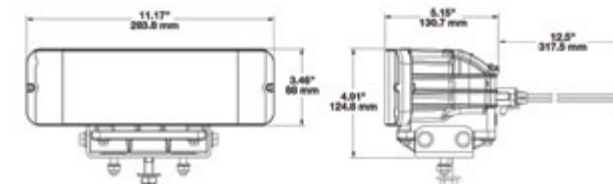

HEATED, DOT



NON-HEATED, DOT HEATED, ECE

HEATED KIT OF 2 HEADLIGHTS

PART #	DESCRIPTION
0552243	12V DOT Heated High & Low Beam w/ Turn - Kit of 2
0551803	24V DOT Heated High & Low Beam w/ Turn - Kit of 2
0552423	12V ECE RHT Heated High & Low Beam w/ Turn, FP & DRL - Kit of 2
0551833	24V ECE RHT Heated High & Low Beam w/ Turn, FP & DRL - Kit of 2
0552433	12V ECE LHT Heated High & Low Beam Turn, FP & DRL - Kit of 2
0551863	24V ECE LHT Heated High & Low Beam w/ Turn, FP & DRL - Kit of 2

If your vehicle is operated in the United States you do NOT need to connect the Front Position wire (red) unless your vehicle is equipped with a front position light.

WARNING: Cancer and Reproductive Harm - www.P65Warnings.ca.gov
AVERTISSEMENT: Cancer et effet nocif sur la reproduction - www.P65Warnings.ca.gov

NON-HEATED KIT OF 2 HEADLIGHTS

PART #	DESCRIPTION
0550061	12-24V DOT High & Low Beam w/ Turn - Kit of 2
0550161	12-24V ECE RHT High & Low Beam w/ Turn, FP & DRL - Kit of 2
0550171	12-24V ECE LHT High & Low Beam w/ Turn, FP & DRL - Kit of 2

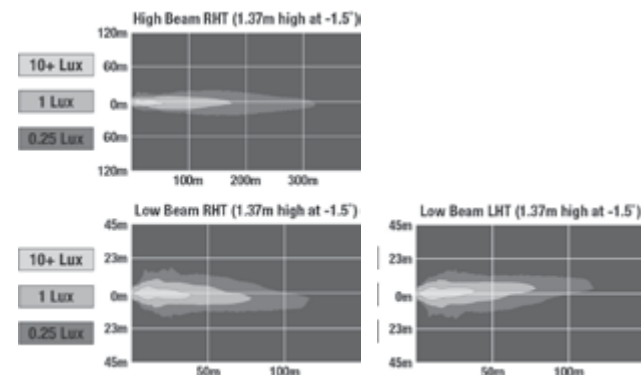

HEATED KIT OF 2 HEADLIGHTS

PART #	DESCRIPTION
0555743	12-24V DOT HS Heated High & Low Beam w/ Turn & FP - Kit of 2

If your vehicle is operated in the United States you do NOT need to connect the Front Position wire (red) unless your vehicle is equipped with a front position light.

WARNING: Cancer and Reproductive Harm - www.P65Warnings.ca.gov
AVERTISSEMENT: Cancer et effet nocif sur la reproduction - www.P65Warnings.ca.gov

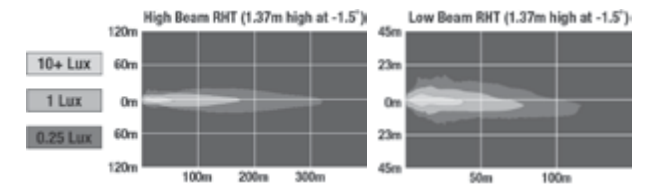



Product Specifications

Raw Lumen Output:
4300 (High Beam); 2370 (Low Beam)

Effective Lumen Output:
1060 (High Beam); 587 (Low Beam)

Candela Output:
58,000 (High Beam)

Connector/Wiring:
6-Pin Delphi (#12052848)

Operating Voltage:
9-30V DC

Current Draw:
High Beam: 5.00A @ 12V DC; 3.00A @ 24V DC
Low Beam: 3.50A @ 12V DC; 2.25A @ 24V DC
Turn: 1.20A @ 12V DC; .75A @ 24V DC
Front Position: 2.00A @ 12V DC; 1.50A @ 24V DC
DRL: 2.50A @ 12V DC; 1.75A @ 24V DC

Retrofit Information:
3" x 13" Rectangle; Pedestal Mount Headlights

Standards & Application:

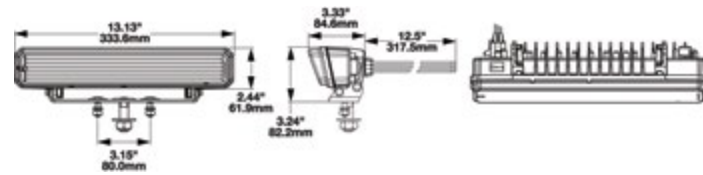

HEATED KIT OF 2 HEADLIGHTS

PART #	DESCRIPTION
0556273	12-24V DOT/ECE RHT Heated LP High & Low Beam w/ Turn, FP & DRL - Kit of 2
0556383	12-24V ECE LHT Heated LP High & Low Beam w/ Turn, FP & DRL - Kit of 2

If your vehicle is operated in the United States you do NOT need to connect the Front Position wire (red) unless your vehicle is equipped with a front position light.

WARNING: Cancer and Reproductive Harm - www.P65Warnings.ca.gov
AVERTISSEMENT: Cancer et effet nocif sur la reproduction - www.P65Warnings.ca.gov

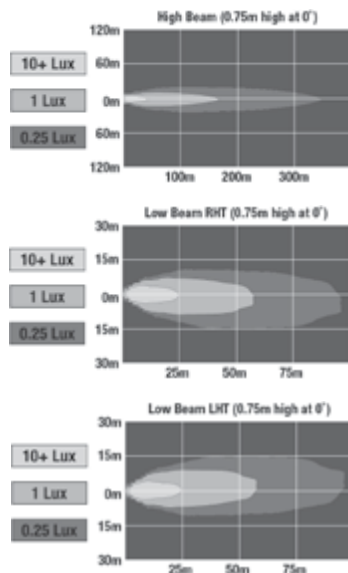

Product Specifications

Raw Lumen Output:
9,800

Effective Lumen Output:
1,650

Candela Output:
Max 150,000

Connector or Wiring:
Deutsch DT06-2S

Operating Voltage:
9-30V DC

Current Draw:
5.0A @ 12V DC (High Beam)
2.7A @ 24V DC (High Beam)

Retrofit Information:
Universal Pedestal Mount

Standards & Application:

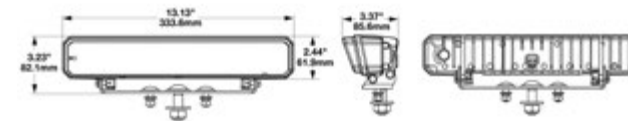

AUXILIARY HIGH BEAM LIGHT BAR

PART #	DESCRIPTION
0561521	12-24V ECE LED High Beam Auxiliary Light with Bracket Mount
0561531	12-24V ECE LED Heated High Beam Auxiliary Light with Bracket Mount

WARNING: Cancer and Reproductive Harm - www.P65Warnings.ca.gov
AVERTISSEMENT: Cancer et effet nocif sur la reproduction - www.P65Warnings.ca.gov

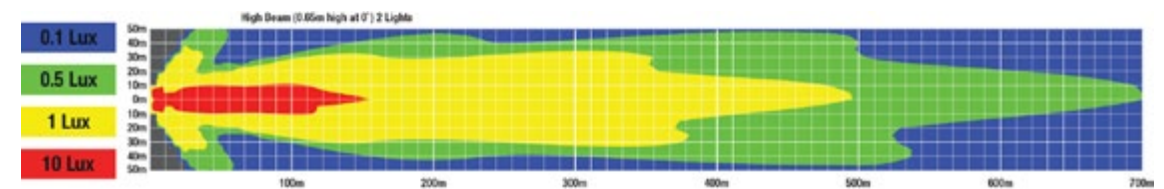

TRAIL 6 AMBER/WHITE.



Ultimate visibility for maximum safety.

J.W. Speaker's Trail 6 Amber/White™ allows for better safety and visibility with bright white or amber LEDs. Illuminate the work site with brilliant white light, or cut through dust and fog with amber LEDs to see every potential hazard. Easily mount on any vehicle with the Trail 6 Amber/White™ custom lighting system with over 1,300 Effective Lumens of bright light.

Total control and customization.

You need reliable, bright lights that work as hard as you do. This compact, durable work light offers total LED color control with two wire and three wire install options to match any vehicle's needs. The Trail 6 Amber/White™ is compact, powerful, easy to mount on any vehicle as a bracket, hanging, or panel mount for a custom lighting system.



TRAIL 6 AMBER/WHITE.

PRODUCT SPECIFICATIONS

Raw Lumen Output:

3,600 (High Beam); 3,020 (Low Beam)

Effective Lumen Output:

1,320 (High Beam); 1,201 (Low Beam)

Candela Output:

68,800 (High Beam); 24,800 (Low Beam)

Connector/Wiring:

H13 Delphi 15326813

Operating Voltage:

9-16V DC

Current Draw:

High Beam: 3.25A @ 12V DC

Low Beam: 2.33A @ 12V DC

Front Turn: 3.00A @ 12V DC

(DRL): 3.00A @ 12V DC

Front Position: 0.45A @ 12V DC

Retrofit Information:

Jeep JK 2010-2018

Standards & Application:

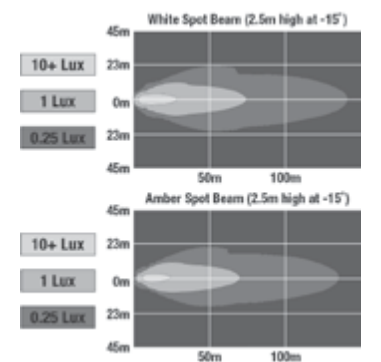
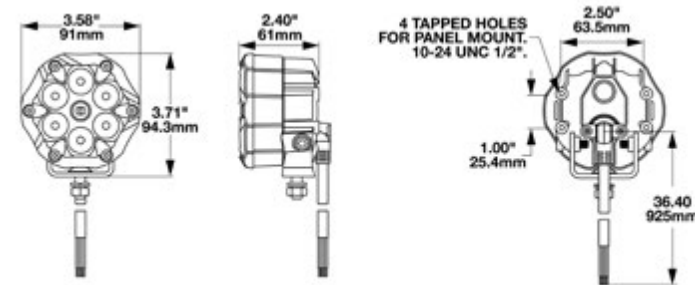

KIT OF 2 FOG LIGHTS

PART #	DESCRIPTION
0557833	12-24V LED Amber/White Work Light

⚠ **WARNING:** Cancer and Reproductive Harm - www.P65Warnings.ca.gov
 ⚠ **AVERTISSEMENT:** Cancer et effet nocif sur la reproduction - www.P65Warnings.ca.gov

EXPERIENCE THE FUTURE OF SAFER WINTER DRIVING.



HEADLIGHTS



SNOW FLOW LIGHTS



WORK LIGHTS



TAIL LIGHTS



Explore more in the World of SmartHeat!

DON'T LET SNOW AND ICE SLOW YOU DOWN.

The SmartHeat[®] Series provide a complete solution for outfitting over-the-road trucks, snow plows, refuse trucks, construction equipment, delivery vans and any heavy-duty vehicle that needs to operate in the winter, covering forward and rear lighting, as well as task lighting. It's the industry's most comprehensive heated LED lighting line-up.

The technology behind SmartHeat[®] enables widespread use of brighter, whiter, long-lasting LED lighting all winter long and is designed to use less power than halogen lighting systems for a more efficient result. This helps owner-operators and fleets improve their utilization and productivity while enhancing the ability to see and be seen on the road, thus ensuring safety and comfort.

Learn more at www.jwspeaker.com/world-of-smarheat/



HOW IT WORKS

SmartHeat[®] Technology will automatically turn on at startup or when temperatures drop.

The SmartHeat[®] technology uses an internal sensor to sense the current temperature.

If the technology senses the temperature to be below the low temperature threshold, the heat will stay on to de-ice the lens.

If the technology senses the temperature to be above the high temperature threshold, the SmartHeat grid system will automatically turn off. This keeps the lamp from overheating when facing warmer conditions.

		Light Temperature		
Air Temperature		ON	ON	OFF
		ON	OFF	OFF
		N/A	OFF	OFF



INDUSTRIAL

Products featured: Model 892, Model 93, and Bobcat LED Headlights

NEW 5-IN-1 93



All New 5-in-1 Headlight

J.W. Speaker's LED Model 93 are the new standard for 90mm lights, providing a drop-in replacement or pedestal mounts for original equipment manufacturers (OEMs), up-fitters, vehicle fleets, and individuals looking for the best-performing LED lights. Engineered as a 5-in-1 LED headlight, the Model 93 offers Low Beam, High Beam, Daytime Running Light (DRL), Front Position, and Turn Signal functionality all in one light. The headlight offers many applications for a variety of vehicles suited for agriculture, automotive, construction, industrial, material handling, mining, motorcycle, off-road 4x4, railroad, specialty vehicles, and truck and bus. Our re-designed die cast aluminum housing features a sealed integrated connector to meet the harsh demands of transportation and municipal applications.

PRODUCT SPECIFICATIONS

Raw Lumen Output:
5-in-1: 1,827 (High Beam); 1,325 (Low Beam)
Low Beam: 1,910

Effective Lumen Output:
5-in-1: 683 (High Beam); 495 (Low Beam)
Low Beam: 575

Candela Output:
5-in-1: 45,000 (High Beam); 23,000 (Low Beam)
Low Beam: 18,000

Connector/Wiring:
Deutsch DT04-2P

Mating Connector:
Deutsch DT06-6S

Operating Voltage:
5-in-1: 9-30V DC
Low Beam: 10-31V DC

Current Draw*:
High Beam: 0.80A @ 12V DC; 0.40A @ 24V DC
Low Beam: 1.97A @ 12V DC; 0.98A @ 24V DC
* For the full listing of Current Draws, please visit the respective Product Number's Specification Sheet on our website at www.jwspeaker.com

Standards & Application:



SINGLE HEADLIGHTS

BEAM PATTERNS

3-POINT MOUNT

PART #	DESCRIPTION	BEAM PATTERNS					3-POINT MOUNT	
		LOW BEAM	HIGH BEAM	DRL	FP	DI	1.5mm	3mm
0560371	12-24V DOT/ECE R112 RHT 5-in-1 Headlight	X	X	X	X	X		X
0560381	12-24V ECE R112 LHT 5-in-1 Headlight	X	X	X	X	X		X
0560501	12-24V ECE R113 5-in-1 Headlight	X	X	X	X	X		X
0554381	12-24V DOT/ECE High Beam Headlight with FP		X		X		X	X
0553071	12-24V DOT/ECE High Beam Headlight		X				X	X
0553091	12-24V ECE R112 LHT Low Beam Headlight	X					X	X
0553101	12-24V DOT/ECE R112 RHT Low Beam Headlight	X					X	X
0553081	12-24V DOT/ECE R113 Agriculture Low Beam Headlight	X					X	X
0556701	12-24V SAE/ECE Fog Light						X	X
0347941	12-24V SAE/ECE Turn Signal & DRL			X		X	X	X

For parts offered in bulk quantities, please visit the J.W. Speaker website.

MOUNTING OPTIONS

PART #	DESCRIPTION	APPLICATION
8001461	3-point Mount for 1.5mm Mounting Frame	See Above
8001471	3-point Mount for 3mm Mounting Frame	See Above
8201021	3-Point Lock Mount for 3mm Mounting Frame	See Above
8001621	Double Lamp Pedestal Mount Bracket	Any Light
8001601	Single Pedestal Mount Bracket	Any Light

WARNING: Cancer and Reproductive Harm - www.P65Warnings.ca.gov
AVERTISSEMENT: Cancer et effet nocif sur la reproduction - www.P65Warnings.ca.gov

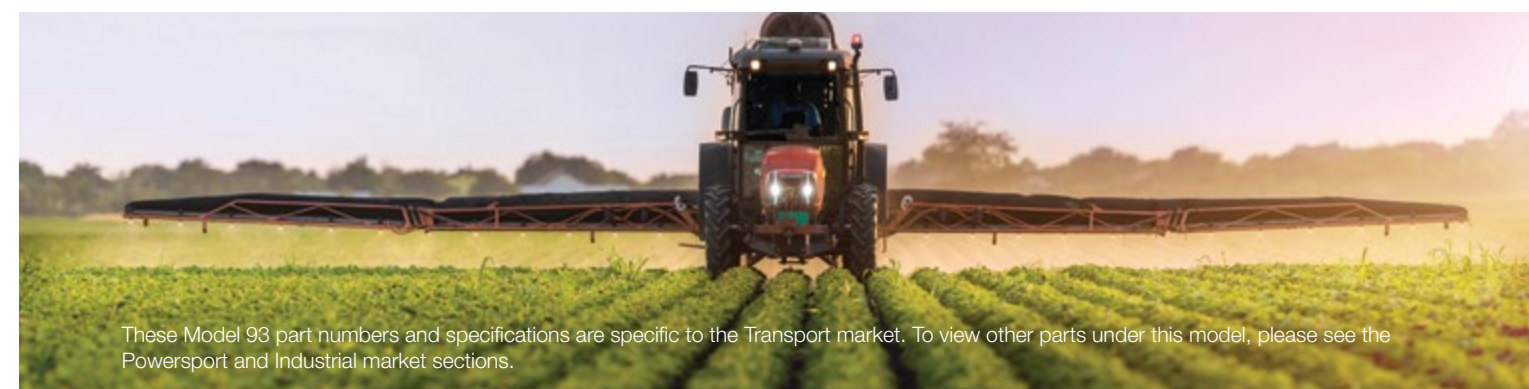
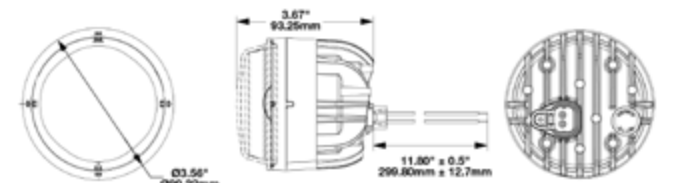
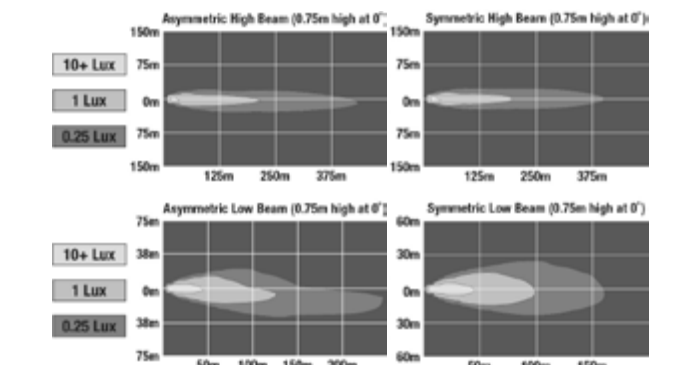

These Model 93 part numbers and specifications are specific to the Transport market. To view other parts under this model, please see the Powersport and Industrial market sections.



Product Specifications

Raw Lumen Output:
1,800 (High Beam); 1,600 (Low Beam)

Effective Lumen Output:
497 (High Beam); 321 (Low Beam)

Candela Output:
41,800 (High Beam); 14,600 (Low Beam)

Connector/Wiring:
Deutsch DT04-4P

Operating Voltage:
10-32V DC

Current Draw:
High Beam: 1.8A @ 12V DC; 1.0A @ 24V DC
Low Beam: 1.5A @ 12V DC; 0.8A @ 24V DC
Front Position: 0.1A @ 12V DC; 0.06A @ 24V DC

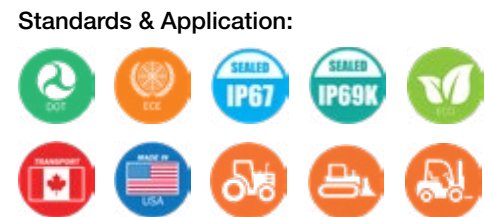

REG 113

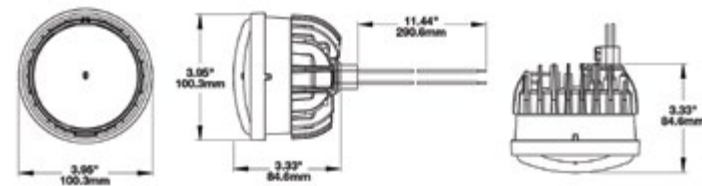

Product Specifications

Raw Lumen Output:
765

Effective Lumen Output:
380

Connector/Wiring:
11" Bare Leads

Operating Voltage:
10-32V DC

Current Draw:
0.340A @ 24V DC

Standards & Application:

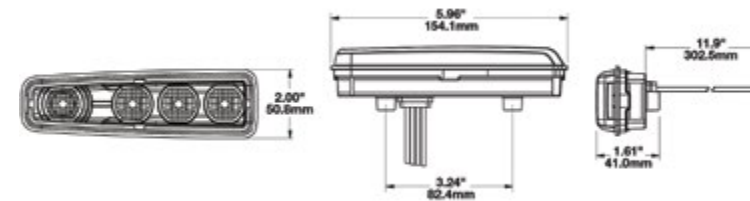

SINGLE HEADLIGHTS

PART #	DESCRIPTION
0554911	12-24V ECE LHT High & Low Beam Headlight (Reg 112)
0554921	12-24V DOT/ECE High & Low Beam Headlight (Reg 113)

PART #	ACCESSORIES
8001511	3-Point Mount for 3mm Mounting Frame
8001521	Single Lamp Pedestal Mount Kit

⚠ **WARNING:** Cancer and Reproductive Harm - www.P65Warnings.ca.gov
 ⚠ **AVERTISSEMENT:** Cancer et effet nocif sur la reproduction - www.P65Warnings.ca.gov

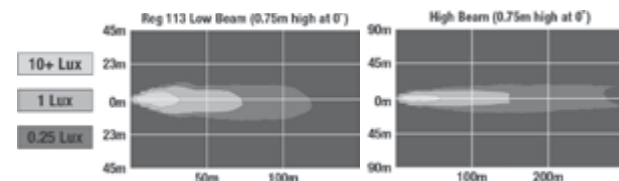

SINGLE PEDESTAL 3-POINT MOUNT

SINGLE HEADLIGHT

PART #	DESCRIPTION
0549482	12-24V LED Material Handling Headlight with Turn & FP

⚠ **WARNING:** Cancer and Reproductive Harm - www.P65Warnings.ca.gov
 ⚠ **AVERTISSEMENT:** Cancer et effet nocif sur la reproduction - www.P65Warnings.ca.gov

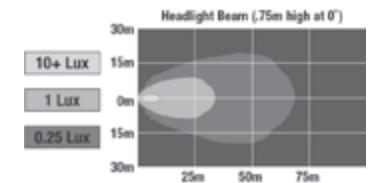

Product Specifications

Raw Lumen Output:
1,470

Effective Lumen Output:
540

Connector/Wiring:
Integrated 4-Pin Deutsch Socket (DT04-4P)

Operating Voltage:
9-32V DC

Current Draw:
Low Beam: 0.923A @ 12V DC; 0.452A @ 24V DC
Front Position: 0.059A @ 12V DC; 0.064A @ 24V DC
Turn Signal: 1.035A @ 12V DC; 0.506A @ 24V DC

Standards & Application:

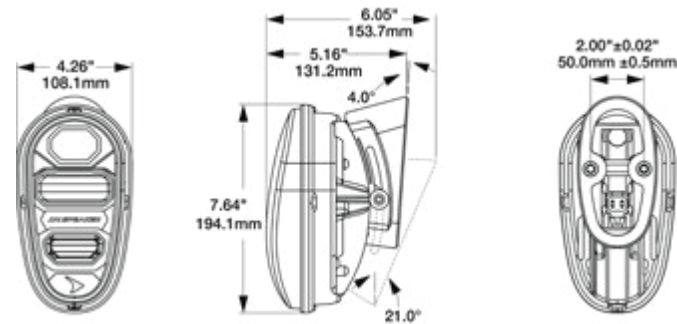

Product Specifications

Raw Lumen Output:
2,000 (6 LEDs); 1,630 (3 LEDs)

Effective Lumen Output:
1,600 (6 LEDs); 780 (3 LEDs)

Connector/Wiring:
2-Pin: Integrated 2-Pin Deutsch
3-Pin: Integrated 3-Pin Packard (12129615)

Operating Voltage:
9-110V DC

Current Draw:
3 LEDs: 1.54A @ 12V DC; 0.67A @ 24V DC; 0.33A @ 60V DC; 0.20A @ 110V DC
6 LEDs: 1.59A @ 12V DC; 0.74A @ 24V DC; 0.34A @ 60V DC; 0.23A @ 110V DC

Standards & Application:

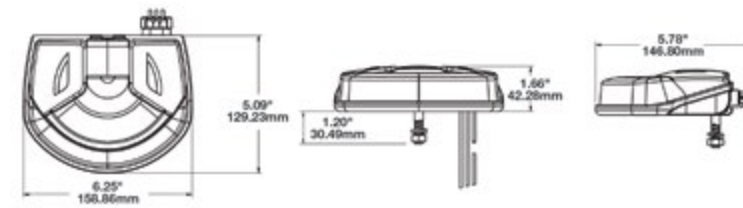
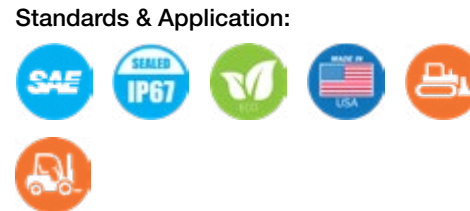

SINGLE HEADLIGHTS

PART #	DESCRIPTION
0561691	12-24V ECE LED Forklift Headlight

PART #	ACCESSORIES
3267401	WIRE ASM, 517 DT06-4S 4-WIRE pkg

▲ **WARNING:** Cancer and Reproductive Harm - www.P65Warnings.ca.gov
▲ **AVERTISSEMENT:** Cancer et effet nocif sur la reproduction - www.P65Warnings.ca.gov

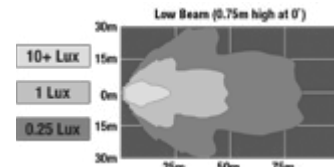

SINGLE HEADLIGHTS

PART #	DESCRIPTION
1000101	12-110V LED 3-Pin Work Light with Vertical Flood Beam Pattern
1000121	12-110V LED 2-Pin Work Light with Vertical Flood Beam Pattern

PART #	ACCESSORIES
8200501	Mounting Kit For Model 710 Work Light

▲ **WARNING:** Cancer and Reproductive Harm - www.P65Warnings.ca.gov
▲ **AVERTISSEMENT:** Cancer et effet nocif sur la reproduction - www.P65Warnings.ca.gov

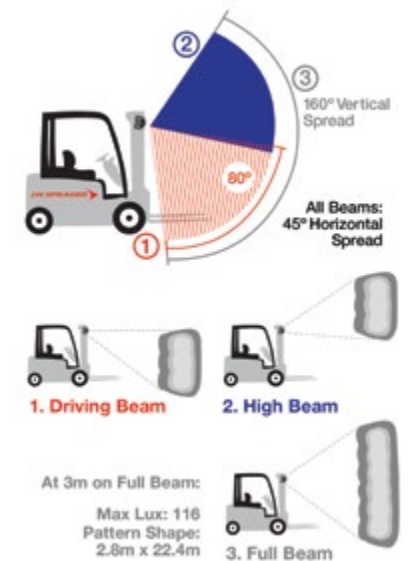

Product Specifications

Raw Lumen Output:
1,820 (Driving/Flood); 800 (Fog)

Effective Lumen Output:
1,200 (Driving/Flood); 250 (Fog)

Candela Output:
6,700 (Fog)

Connector/Wiring:
Driving/Flood: Deutsch DT04-2P
Fog: Integrated 2-Pin Deutsch Connector

Operating Voltage:
Driving/Flood: 9-32V DC
Fog: 10-18V DC

Current Draw:
Driving/Flood: 1.27A @ 12V DC; 0.78A @ 24V DC
Fog: 0.55A @ 10V DC; 0.88A @ 12V DC;
1.10A @ 18V DC

Standards & Application:



Product Specifications

Raw Lumen Output:
Spot/Driving: 1,280
Fog: 800

Effective Lumen Output:
Spot: 520
Driving: 430
Fog: 250

Candela Output:
Spot: 8,600
Driving: 3,000

Connector/Wiring:
Bare Leads

Operating Voltage:
Driving & Spot: 9-32V DC
Fog: 9-18V DC

Current Draw:
1.2A @ 12V DC; 0.6A @ 24V DC

Standards & Application:



FOG



DRIVING

KIT OF 2 FOG LIGHTS

PART #	DESCRIPTION
1603603	12V DOT/ECE LED Fog Light - Kit of 2

SINGLE LIGHTS

PART #	DESCRIPTION
1603601	12V DOT/ECE LED Fog Light
1603511	12-24V LED Driving Light
1603521	12-24V LED Driving Light with Flood Beam Pattern

▲ **WARNING:** Cancer and Reproductive Harm - www.P65Warnings.ca.gov
▲ **AVERTISSEMENT:** Cancer et effet nocif sur la reproduction - www.P65Warnings.ca.gov

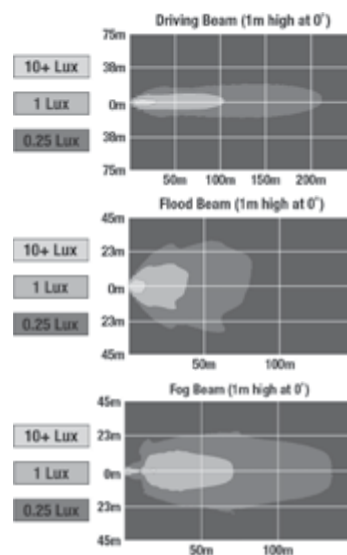

SINGLE HEADLIGHTS

PART #	DESCRIPTION
0543591	12-24V LED Auxiliary Light with Driving Beam Pattern
0548631	12-24V LED Auxiliary Light with Spot Beam Pattern
0549691	12V SAE/ECE LED Auxiliary Light with Fog Beam Pattern
0647101	12-24V LED Color Auxiliary Light - (Red/Blue/Amber/Green)

▲ **WARNING:** Cancer and Reproductive Harm - www.P65Warnings.ca.gov
▲ **AVERTISSEMENT:** Cancer et effet nocif sur la reproduction - www.P65Warnings.ca.gov

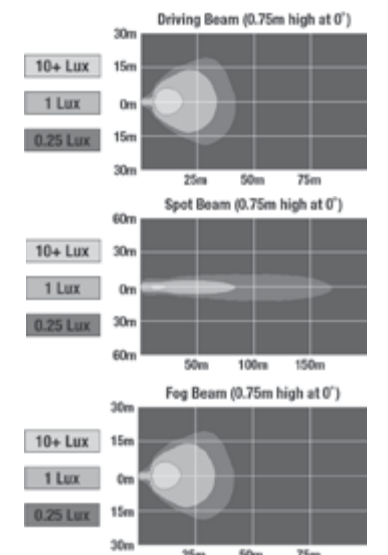

6130 EVOLUTION



Product Specifications

Raw Lumen Output:
2,230 (High Beam); 1,330 (Low Beam);

Effective Lumen Output:
840 (High Beam); 440 (Low Beam);

Connector/Wiring:
12" Flying Leads

Operating Voltage:
10-30V DC

Current Draw:
High Beam: 3.00A @ 12V DC; 1.43A @ 24V DC
Low Beam: 2.30A @ 12V DC; 1.01A @ 24V DC
FP: 0.12A @ 12V DC; 0.09A @ 24V DC

Retrofit Information:
4.75" (PAR38)

Standards & Applications:

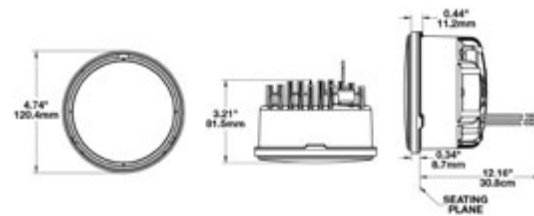

8415 EVOLUTION

Product Specifications

Raw Lumen Output:
1,075 (High Beam); 430 (Low Beam)

Effective Lumen Output:
720 (High Beam); 240 (Low Beam)

Mating Connector:
PE 12110293

Operating Voltage:
10-30V DC

Current Draw:
High Beam: 1.14A @ 12V DC; 0.57A @ 24V DC
Low Beam: 0.41A @ 12V DC; 0.22A @ 24V DC

Standards & Application:

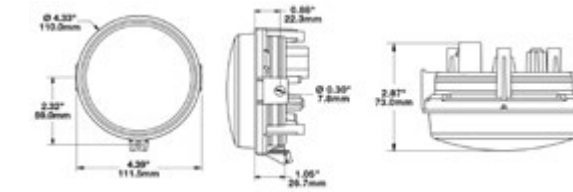

ADJUSTABLE MOUNT



SINGLE HEADLIGHTS

PART #	DESCRIPTION
0549881	12-24V DOT/ECE RHT High & Low Beam w/ FP
0549891	12-24V ECE LHT High & Low Beam w/ FP

If your vehicle is operated in the United States you do NOT need to connect the Front Position wire (red) unless your vehicle is equipped with a front position light.

▲ **WARNING:** Cancer and Reproductive Harm - www.P65Warnings.ca.gov
▲ **AVERTISSMENT:** Cancer et effet nocif sur la reproduction - www.P65Warnings.ca.gov

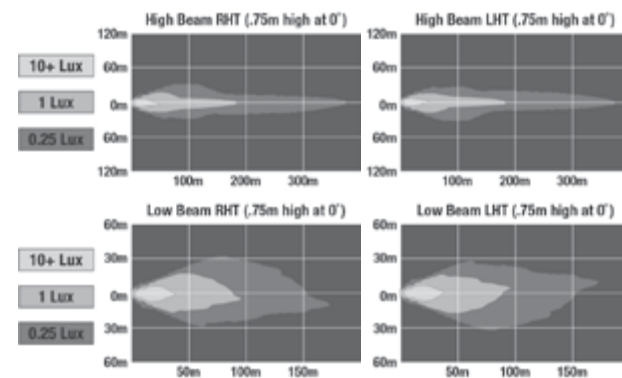

SINGLE HEADLIGHTS

PART #	MOUNT	DESCRIPTION
0551191	Adjustable	12-24V SAE/ECE High/Low Beam w/ Xenoy Housing
0552031	Adjustable	12-24V SAE/ECE High/Low Beam Light w/ Polycarbonate Housing - UL Version
0551761	Fixed	12-24V SAE/ECE High/Low Beam w/ Xenoy Housing

▲ **WARNING:** Cancer and Reproductive Harm - www.P65Warnings.ca.gov
▲ **AVERTISSMENT:** Cancer et effet nocif sur la reproduction - www.P65Warnings.ca.gov

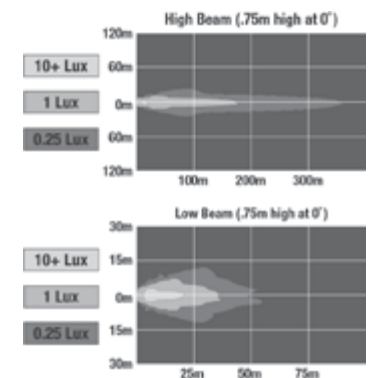

Product Specifications

Raw Lumen Output:
2,200

Effective Lumen Output:
1,800 (Heated); 2,041 (Non-Heated)

Candela Output:
230,000 (Heated); 260,000 (Non-Heated)

Connector/Wiring:
Standard Sealed Beam Style Screw Terminal

Operating Voltage:
18-130V DC

Current Draw:
Heated/Heater On:
High Output: 3.20A @ 24V; 1.20A @ 75V; 0.85A @ 110V DC
Low Output: 2.60A @ 24V; 0.85A @ 75V; 0.75A @ 110V DC
Non-Heated/Heater Off:
High Output: 2.10A @ 24V; 0.75A @ 75V; 0.55A @ 110V DC
Low Output: 1.00A @ 24V; 0.45A @ 75V; 0.30A @ 110V DC

Retrofit Information:
7" Round Locomotive Headlight

Standards & Application:

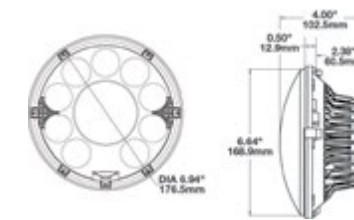

MODEL
8770

HEATED SINGLE HEADLIGHT

PART #	DESCRIPTION
0551901	24-110V LED Heated Locomotive Headlight w/ Spot Beam Pattern
0561031	24-110V LED Locomotive Headlight with Warm White Spot Beam Pattern & Heated Lens

NON-HEATED SINGLE HEADLIGHT

PART #	DESCRIPTION
0554601	24-110V LED Locomotive Headlight with Spot Beam Pattern
0561061	24-110V LED Locomotive Headlight with Warm White Spot Beam Pattern

▲ **WARNING:** Cancer and Reproductive Harm - www.P65Warnings.ca.gov
▲ **AVERTISSEMENT:** Cancer et effet nocif sur la reproduction - www.P65Warnings.ca.gov

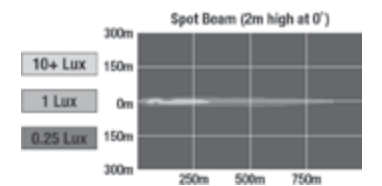



RIGHT HAND



LEFT HAND

RIGHT HAND

Product Specifications

- Raw Lumen Output:**
1728
- Effective Lumen Output:**
1050
- Operating Voltage:**
10-16V DC
- Mating Connector:**
PE 12124819
- Current Draw:**
1.50A @ 12V DC (Flood)
- Retrofit Information:**
Bobcat Skid Steer Loaders and Compact Track Loaders: S590, S595, S630, S650, S740, S750, S770, S850, T450, T550, T590, T595, T630, T650, T740, T750, T770, T870.
- Standards & Application:**

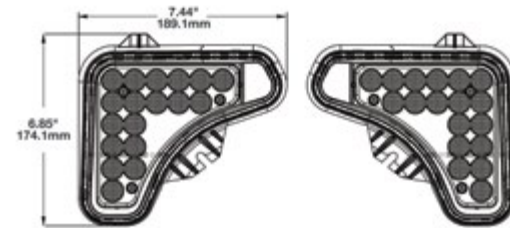

Product Specifications

- Effective Lumen Output:**
1000
- Connector/Wiring:**
Integrated 2-Pin Deutsch Socket (DT04-2P)
- Operating Voltage:**
9-32V DC
- Current Draw:**
2.2A @ 12V DC; 1.1A @ 24V DC
- Retrofit Information:**
Bobcat Skid Steer Loaders and Compact Track Loaders: 751, 753, 763, 773, 863, 864, 873, 883, 963, A220, A300, S130, S150, S160, S175, S185, S205, S220, S250, S300, S330, T140, T180, T190, T200, T250, T300, T320
- Application:**



LEFT HAND

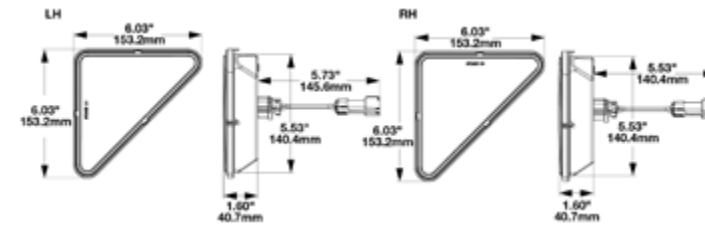

RIGHT HAND

KIT OF 2 HEADLIGHTS

PART #	DESCRIPTION
0557613	12V Gen 5 Bobcat LH & RH LED Flood Headlight - Kit of 2

SINGLE HEADLIGHTS

PART #	DESCRIPTION
0557621	12V Gen 5 Bobcat LH LED Flood Headlight
0557631	12V Gen 5 Bobcat RH LED Flood Headlight

▲ **WARNING:** Cancer and Reproductive Harm - www.P65Warnings.ca.gov
 ▲ **AVERTISSEMENT:** Cancer et effet nocif sur la reproduction - www.P65Warnings.ca.gov

KIT OF 2 HEADLIGHTS

PART #	DESCRIPTION
1000093	12/24V Bobcat LH & RH LED Headlight - Kit of 2

▲ **WARNING:** Cancer and Reproductive Harm - www.P65Warnings.ca.gov
 ▲ **AVERTISSEMENT:** Cancer et effet nocif sur la reproduction - www.P65Warnings.ca.gov



OEM

Technology is constantly evolving. Our attitude towards design remains constant. Relentless innovation and smart partnerships make J.W. Speaker the reliable partner who invests in the design and science of vehicle lighting.

AFTERMARKET

Look good or drive safely. That's often your choice with Aftermarket lights, but J.W. Speaker does not compromise. Our engineers and designers don't cut corners. The result is power and beauty that makes you feel good about the look of your vehicle — and your safety.

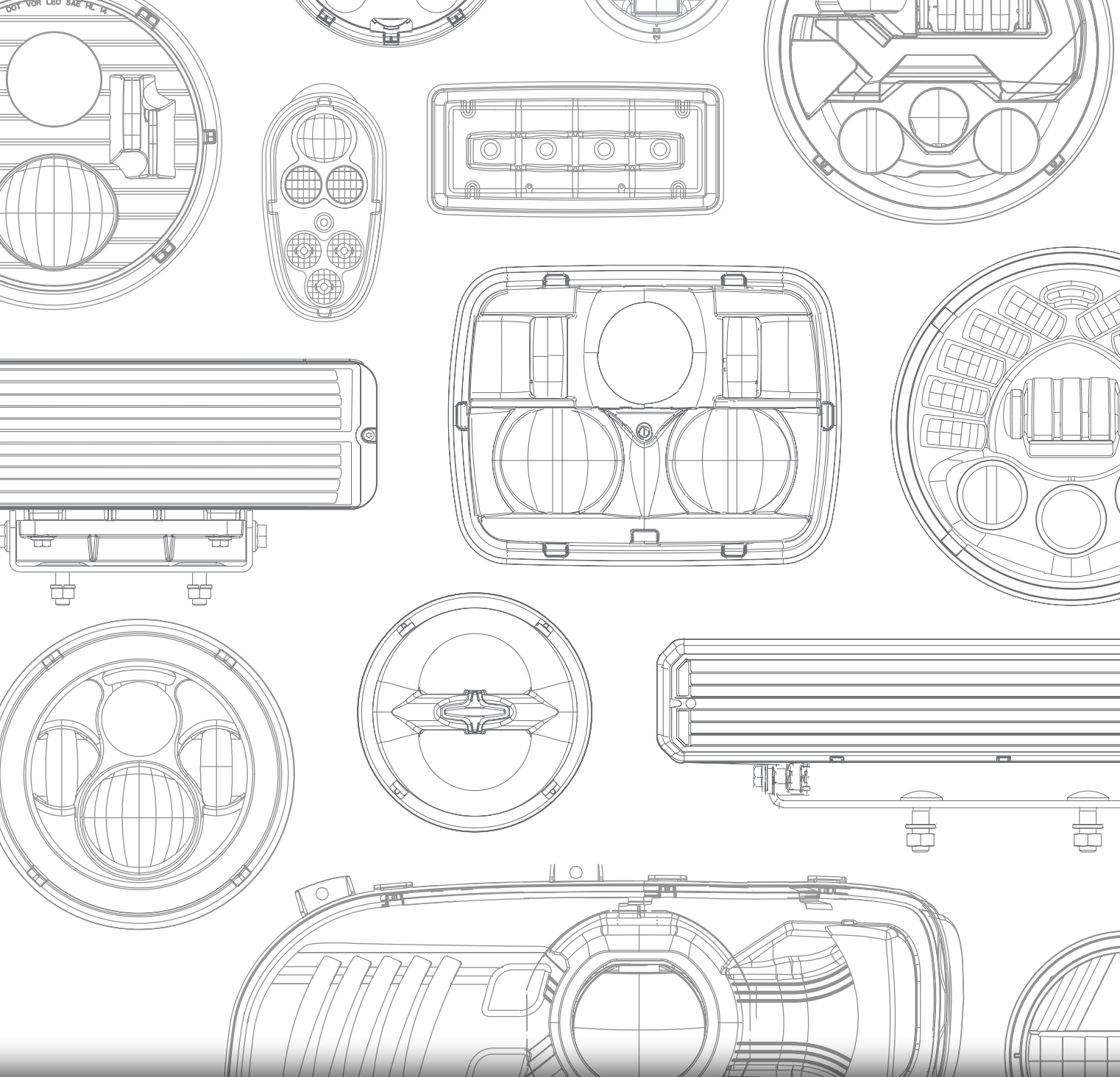

Family owned and operated since 1935.
We proudly designed and engineer the best LED
lighting products, all in Germantown, WI, U.S.A.

www.jwspeaker.com
Email: speaker@jwspeaker.com

